

CASING

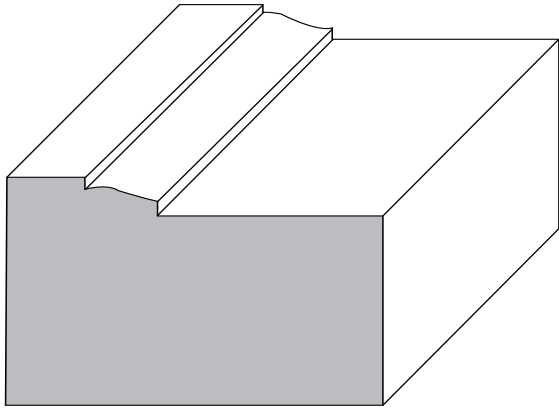

T-WM180
1¹/₄ x 2

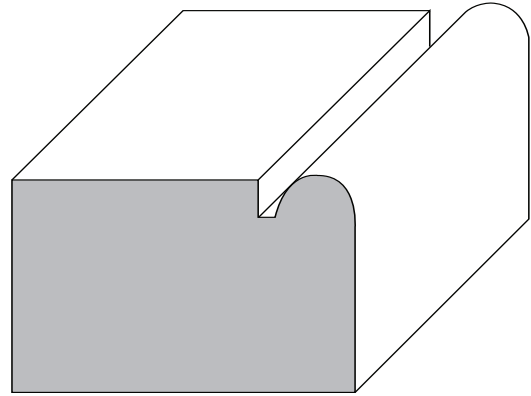

T-WM176
1¹/₁₆ x 1³/₄

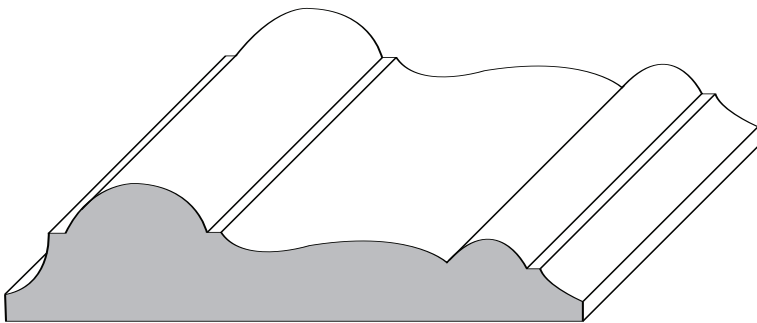

T-WM297
¹¹/₁₆ x 3

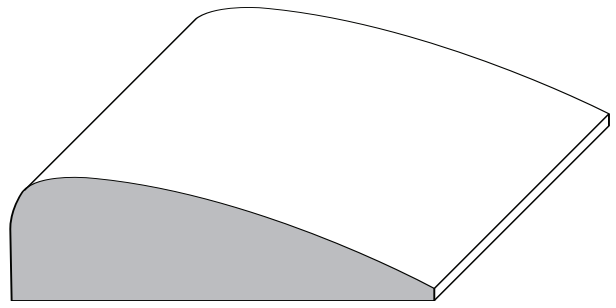

T-WM327
¹¹/₁₆ x 2¹/₄

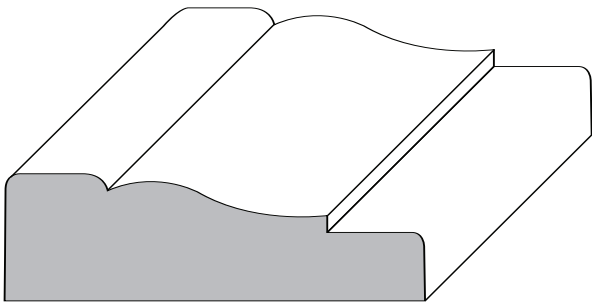

T-WM356
¹¹/₁₆ x 2¹/₄

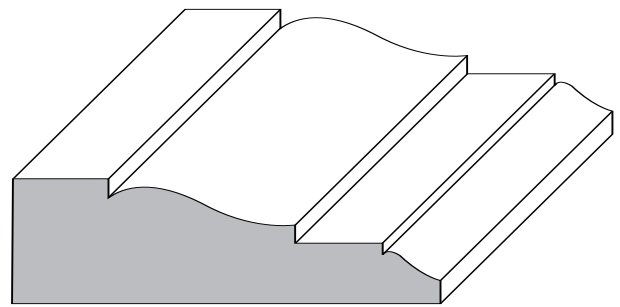

T-WM366
¹¹/₁₆ x 2¹/₄

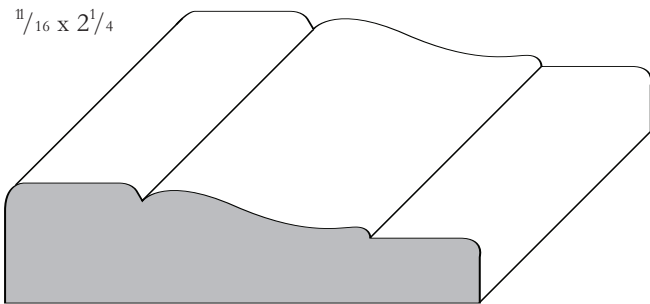

T-WM351
¹¹/₁₆ x 2¹/₂

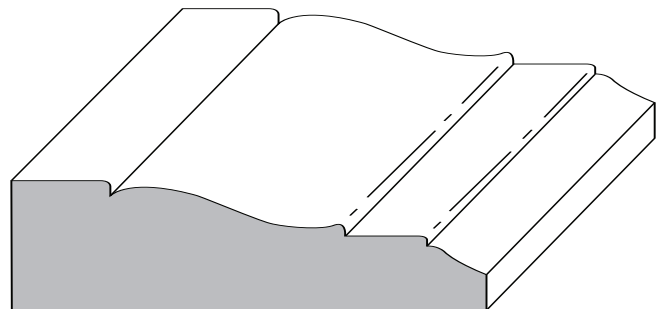

T-WM361
¹¹/₁₆ x 2¹/₂



CASING

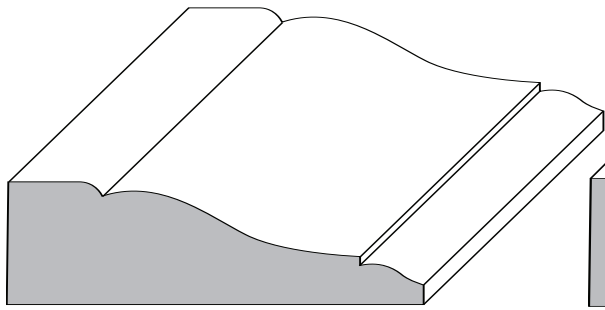

T-WM442
 $\frac{11}{16} \times 2\frac{1}{4}$

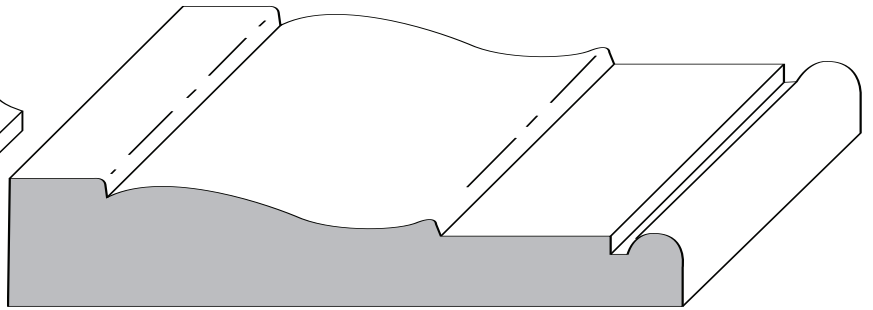

C-LW445
 $\frac{5}{8} \times 3\frac{1}{2}$

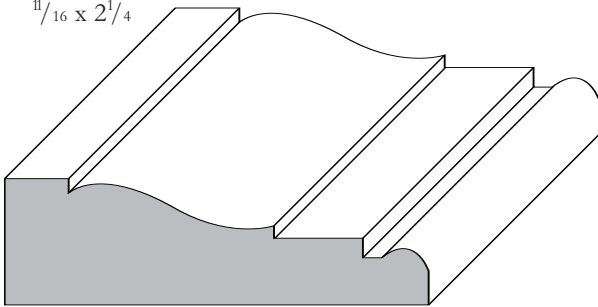

T-WM376
 $\frac{11}{16} \times 2\frac{1}{4}$

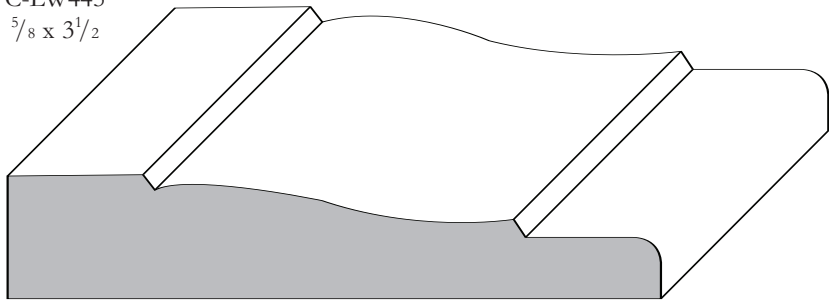

T-WM444
 $\frac{11}{16} \times 3\frac{1}{2}$

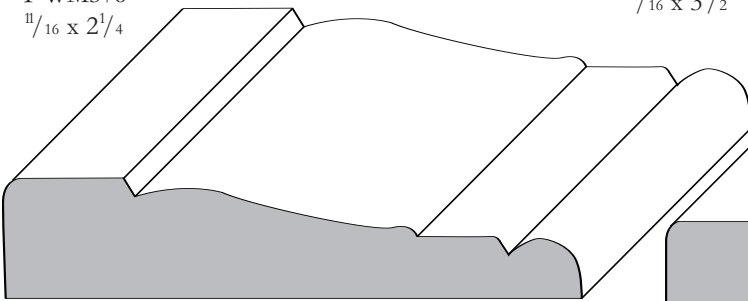

C-LW371
 $\frac{5}{8} \times 3$

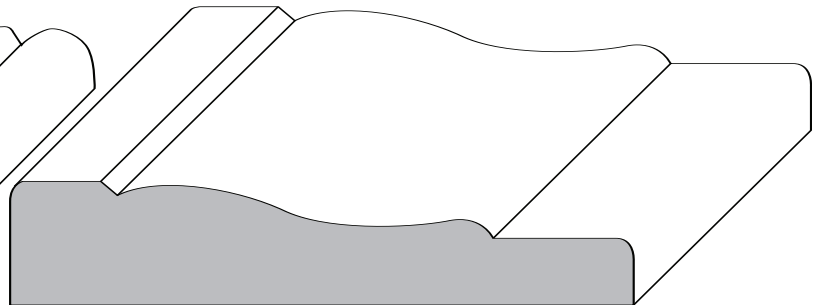

T-CT444
 $\frac{11}{16} \times 3\frac{1}{4}$

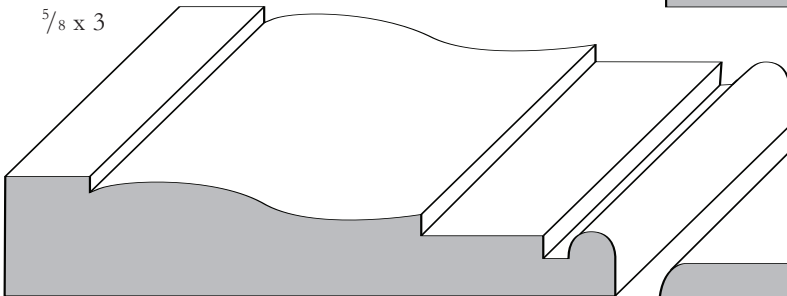

T-WM445
 $\frac{11}{16} \times 3\frac{1}{4}$

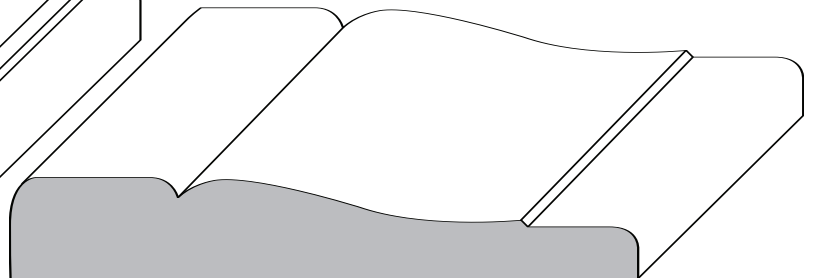

C-LW356
 $\frac{5}{8} \times 3\frac{1}{4}$

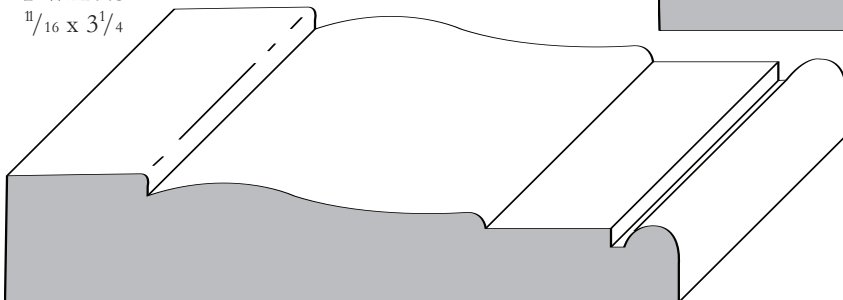

T-WM327
 $\frac{11}{16} \times 2\frac{1}{4}$



CASING



T-WM430
 $\frac{9}{16} \times 4\frac{1}{4}$

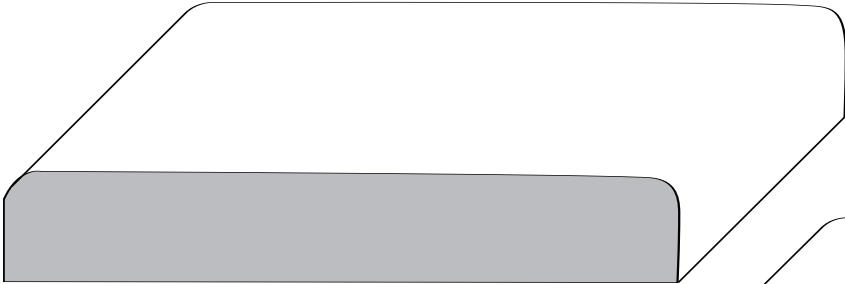

T-WM432
 $\frac{9}{16} \times 3\frac{1}{2}$

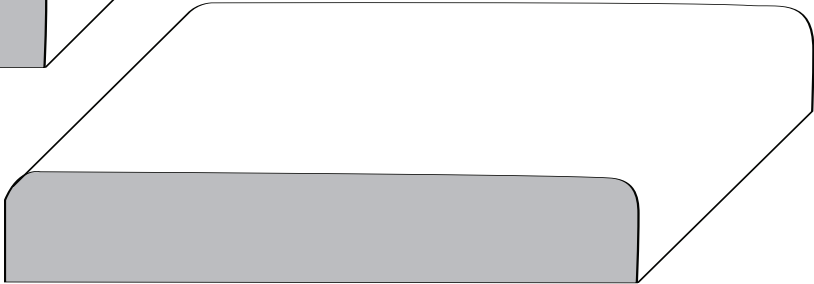

T-WM433
 $\frac{9}{16} \times 3\frac{1}{2}$

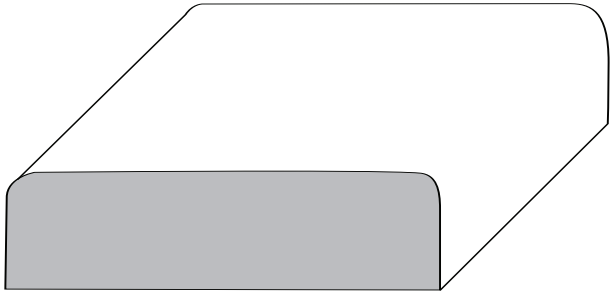

T-WM473
 $\frac{9}{16} \times 2\frac{1}{4}$

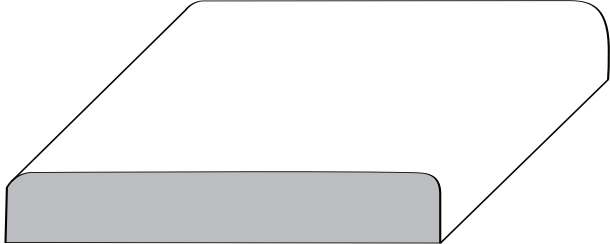

T-WM493
 $\frac{7}{16} \times 2\frac{1}{4}$

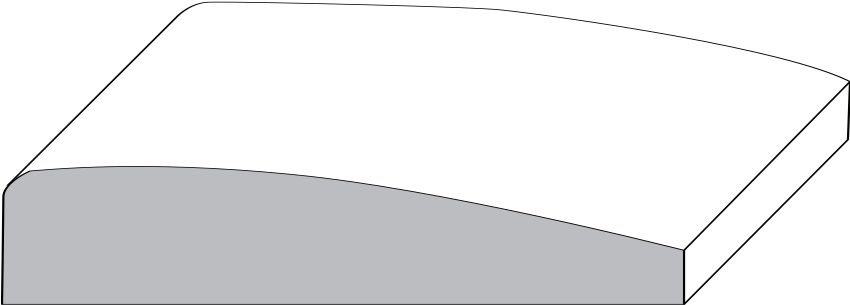

C-P2050
 $\frac{3}{4} \times 3\frac{1}{2}$



CASING

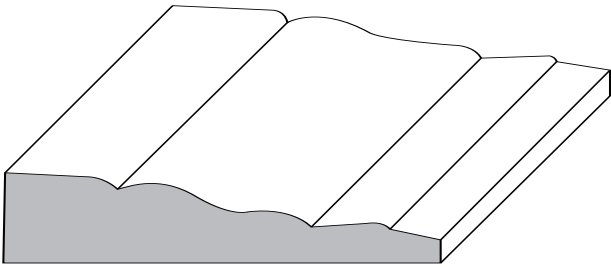

T-FL366
7/16 x 2 1/4

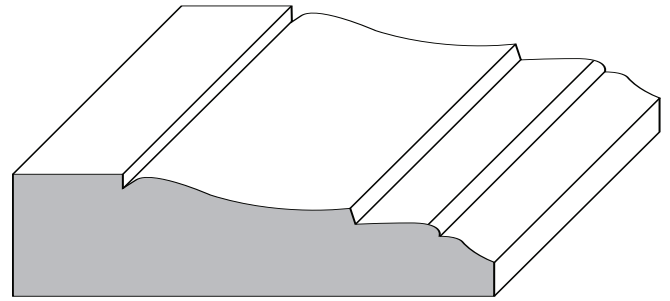

C-NJ149
11/16 x 2 1/2

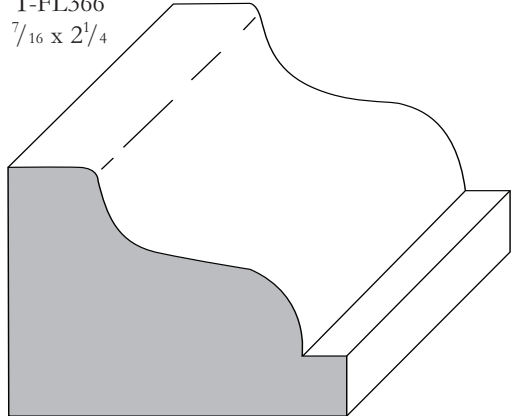

C-RRLO3
1 1/4 x 1 3/4

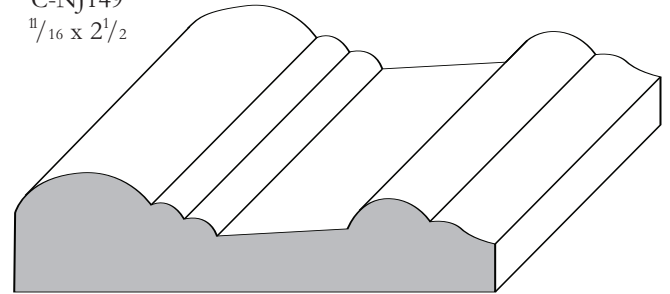

T-SL207
5/8 x 2 1/2

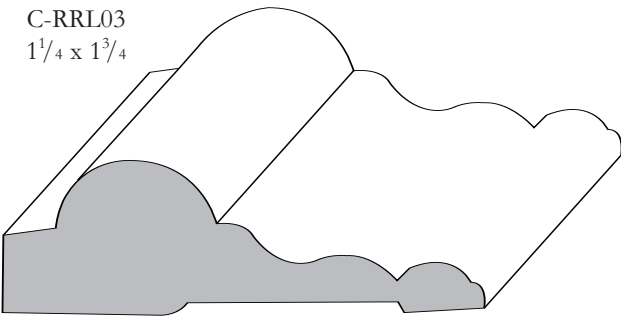

C-RB426
3/4 x 2 1/2

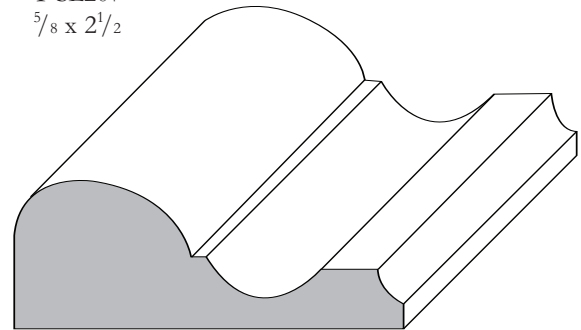

C-PM250
3/4 x 2

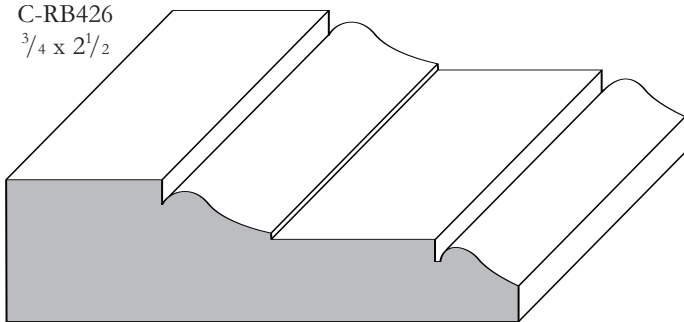

C-SS220
3/4 x 2 5/8

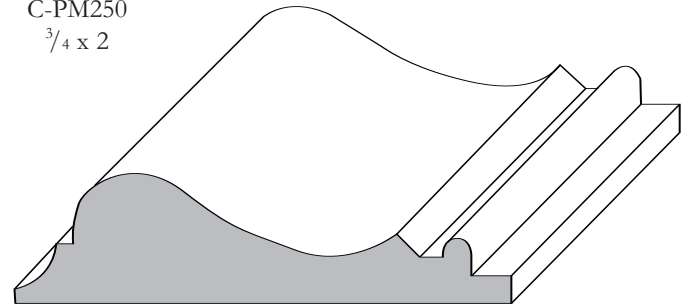

T-WM390
11/16 x 2 5/8

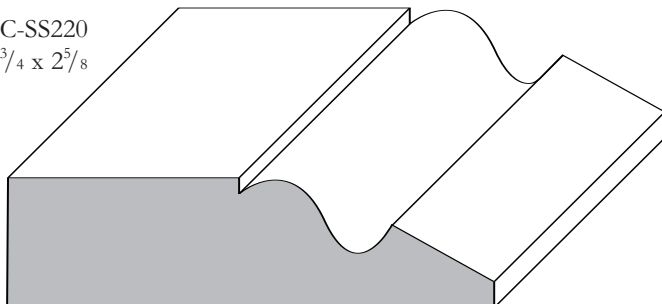

C-PO215
11/16 x 2 1/2

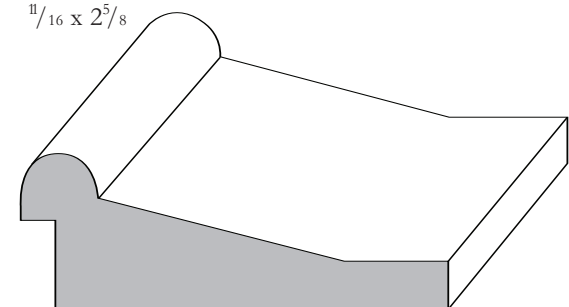

C-214PR
3/4 x 2 1/4



CASING

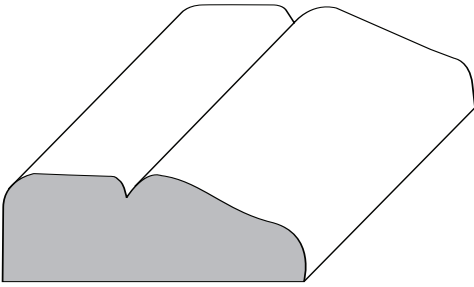

T-SL203
 $\frac{9}{16} \times 1\frac{5}{8}$

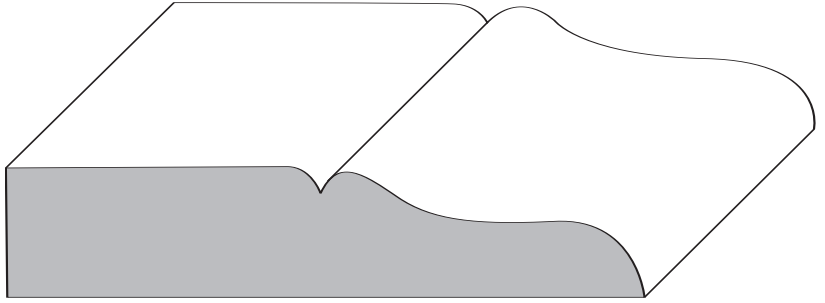

C-S2310
 $\frac{11}{16} \times 3\frac{1}{4}$

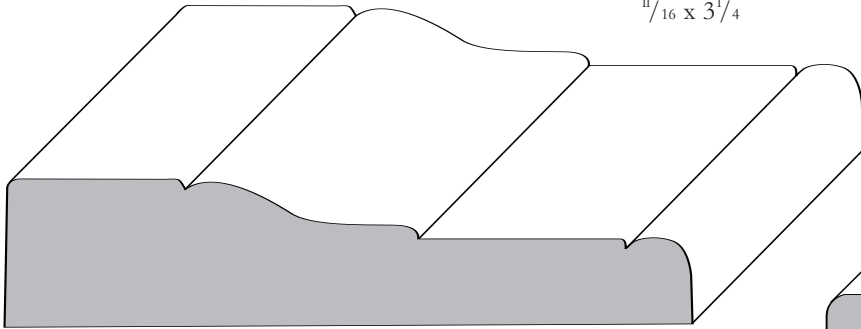

C-PM351
 $\frac{3}{4} \times 3\frac{1}{2}$

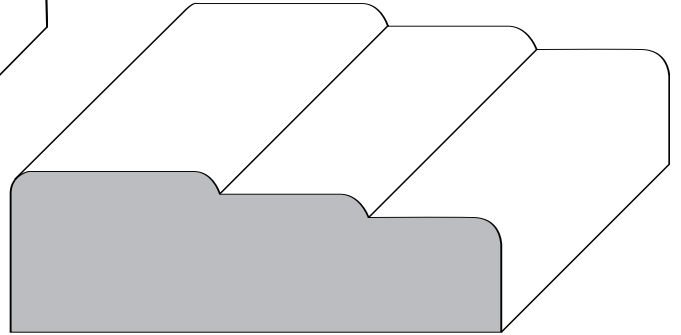

C-TH250
 $\frac{5}{16} \times 2\frac{1}{2}$

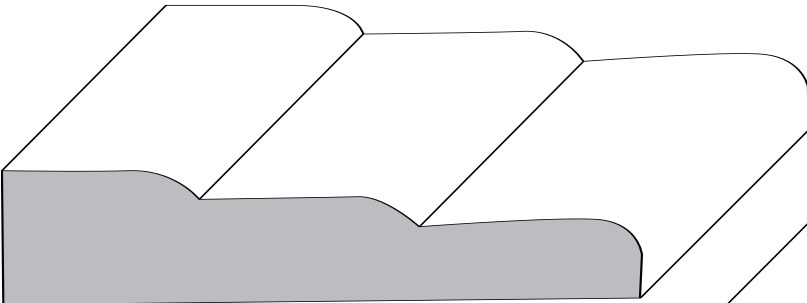

C-DC325
 $\frac{11}{16} \times 3\frac{1}{4}$

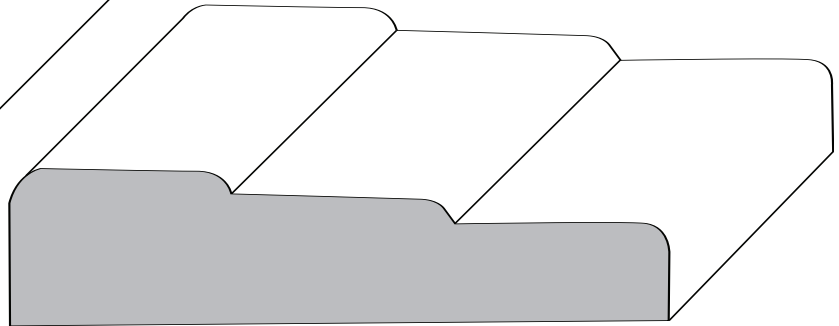

C-LM608
 $\frac{5}{16} \times 3\frac{1}{2}$

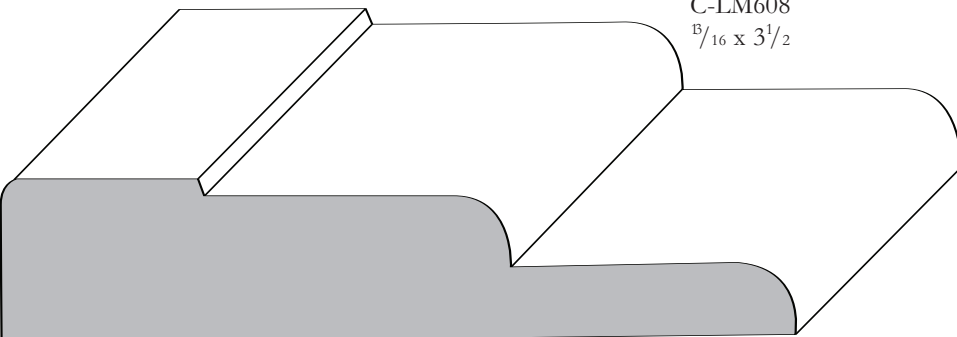

C-DE418
 $\frac{5}{16} \times 4\frac{1}{16}$



CASING

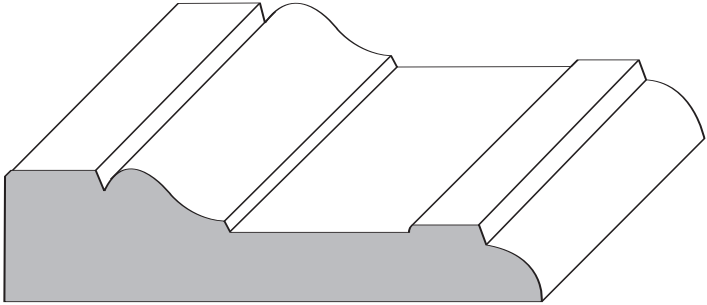

C-DY233
5/8 x 2 3/4

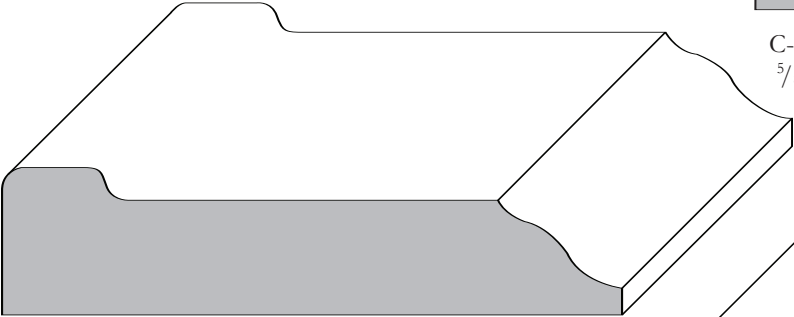

C-ID403
3/4 x 3 1/4

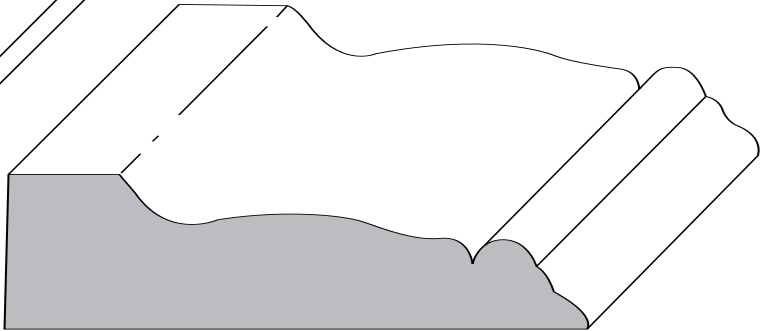

C-EM300
3/4 x 3

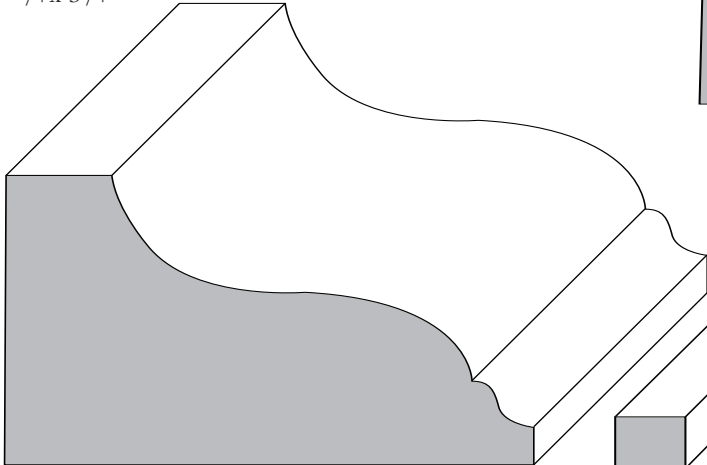

C-NJ802
1 1/2 x 2 3/4

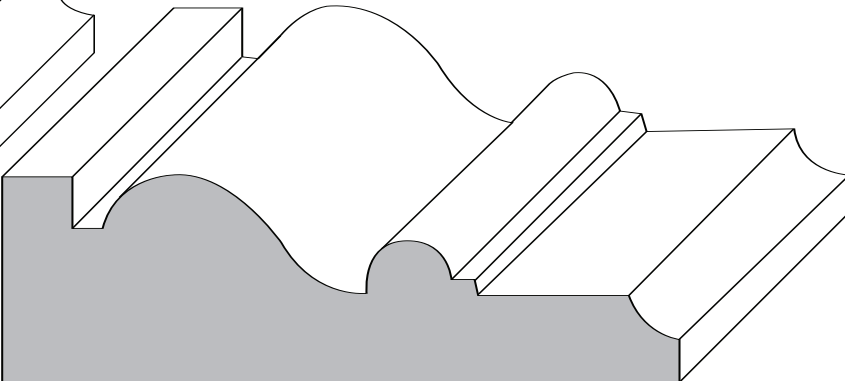

C-AS535
1 1/16 x 3 1/2

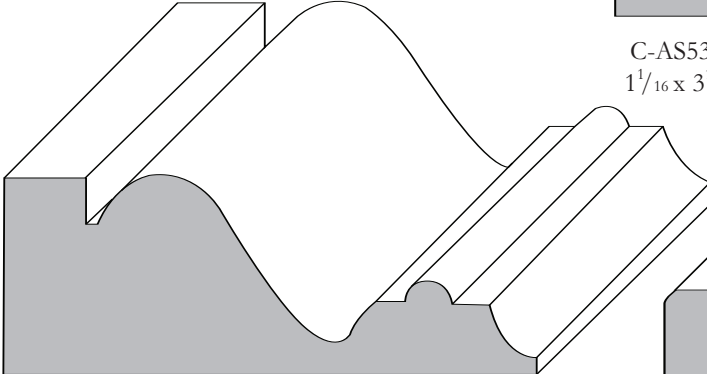

C-NJ802
1 1/2 x 2 3/4

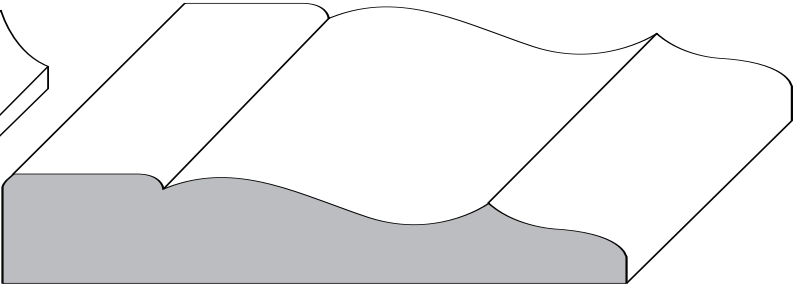

C-RLC22
9/16 x 3 1/4



CASING

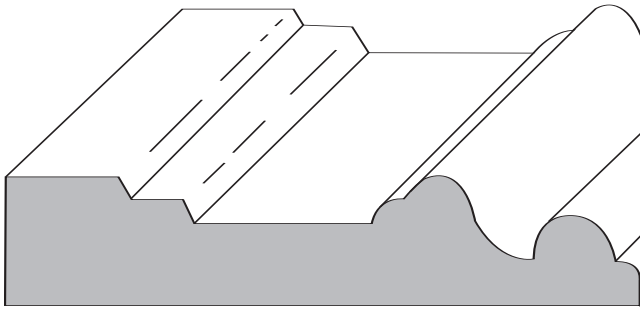

C-CHARL
 $\frac{5}{8} \times \frac{3}{4}$

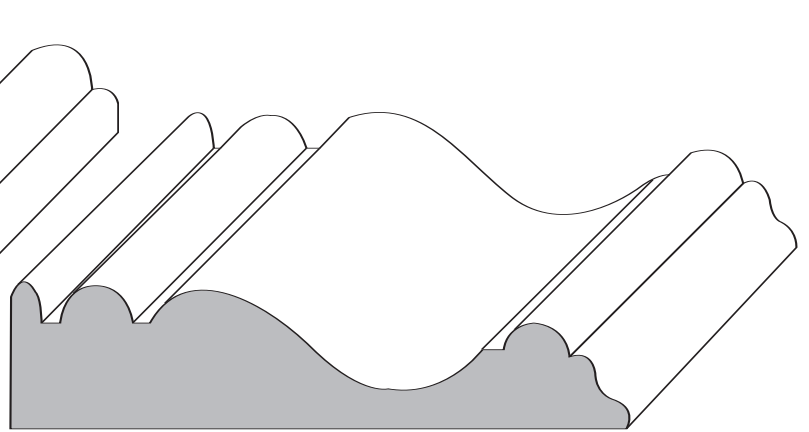

C-R265U
 $\frac{3}{4} \times \frac{3}{4}$

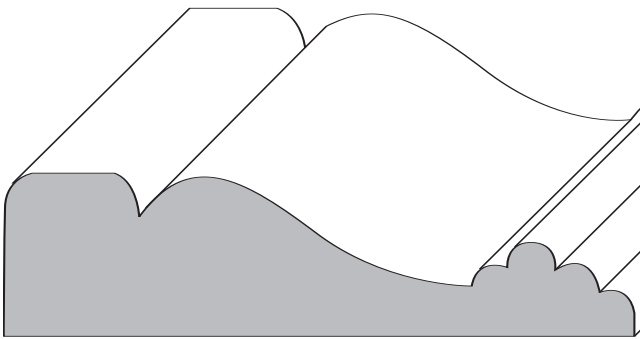

T-SL225
 $\frac{7}{8} \times \frac{3}{4}$

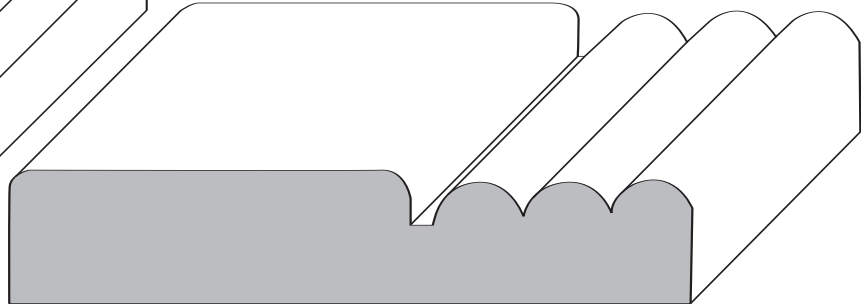

C-PM350
 $\frac{11}{16} \times \frac{3}{2}$

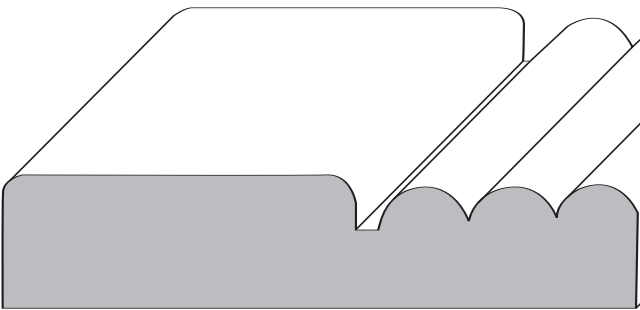

C-DC338
 $\frac{5}{8} \times \frac{3}{8}$

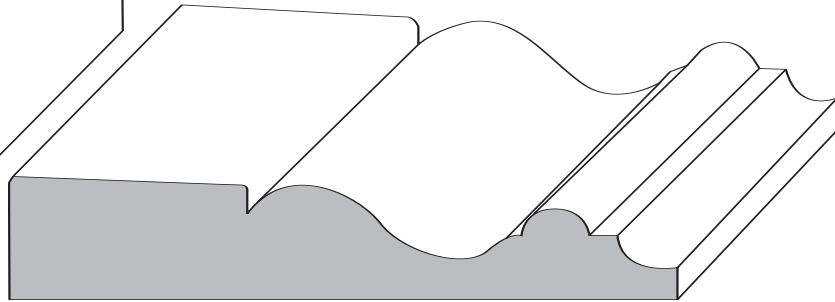

C-VI350
 $\frac{5}{8} \times \frac{3}{2}$

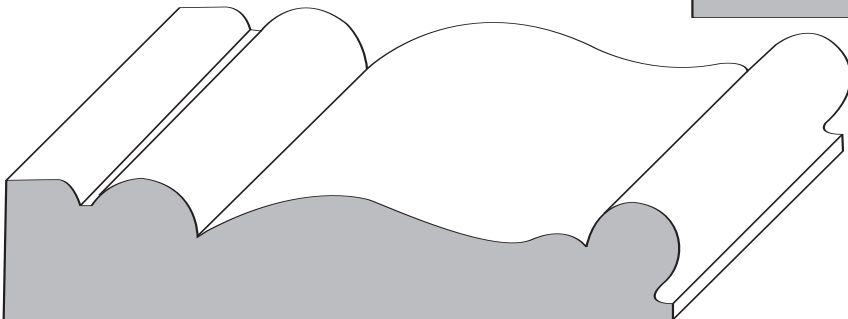

C-DS102
 $\frac{11}{16} \times \frac{3}{2}$



CASING

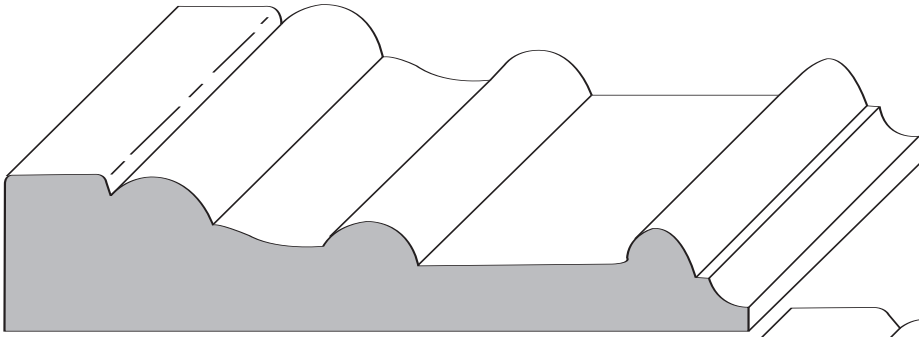

C-EM104
 $\frac{5}{16} \times 3\frac{3}{4}$

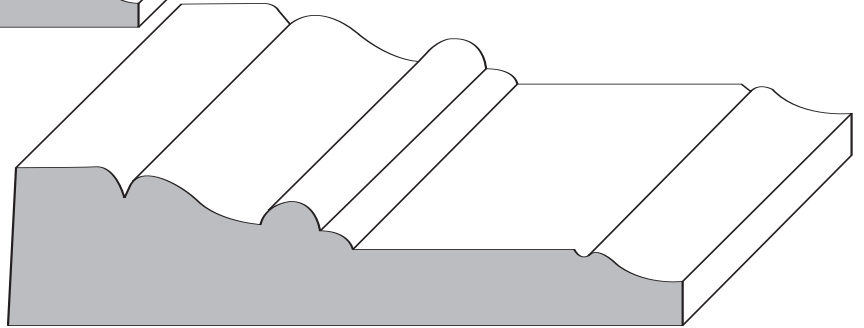

C-SMM3
 $\frac{5}{16} \times 3\frac{1}{2}$

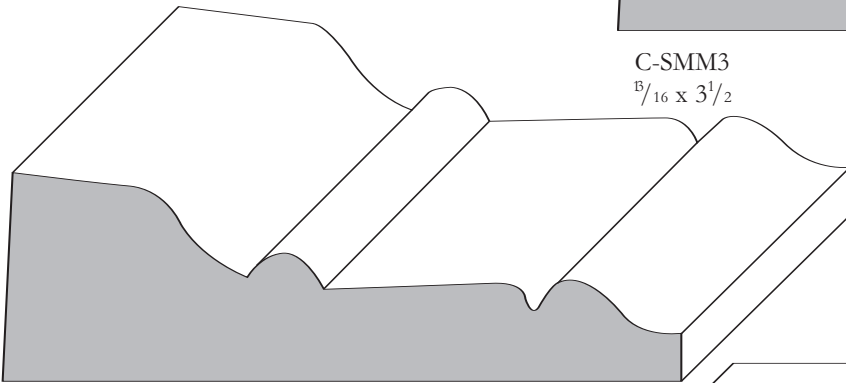

T-C1100
 $1 \times 3\frac{1}{2}$

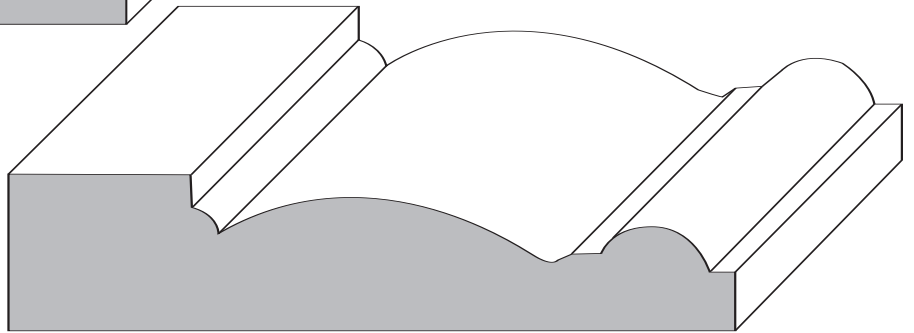

C-PM848
 $\frac{5}{16} \times 3\frac{3}{4}$

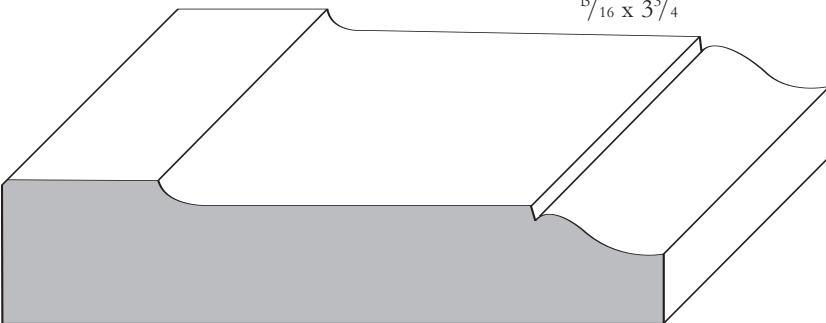

C-M21A
 $\frac{3}{4} \times 3\frac{3}{8}$



CASING

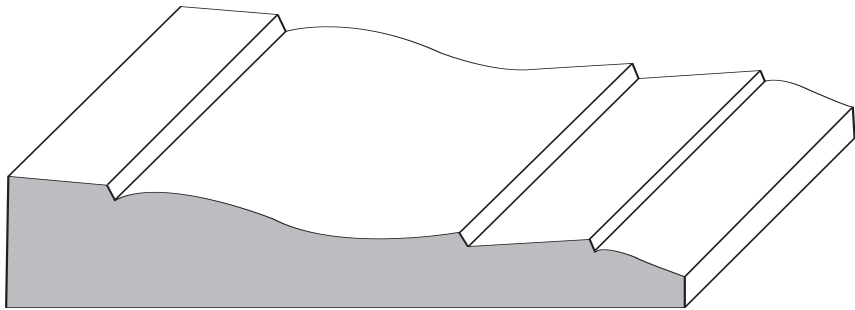

C-L8753
5/8 x 3 1/2

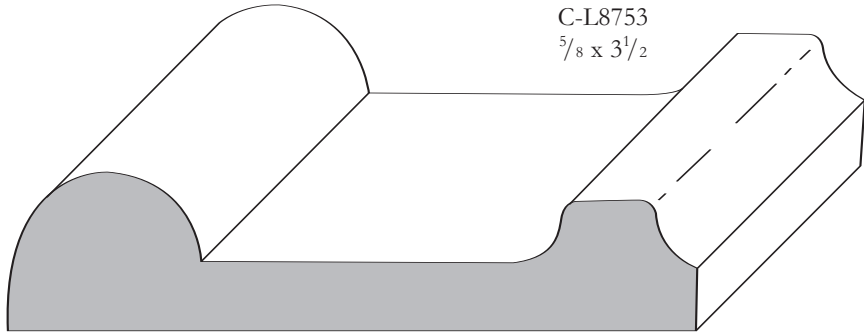

C-L8753
5/8 x 3 1/2

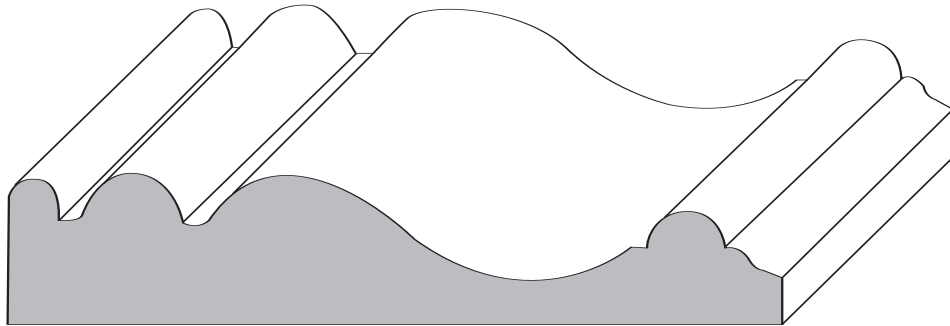

C-R270U
3/4 x 4

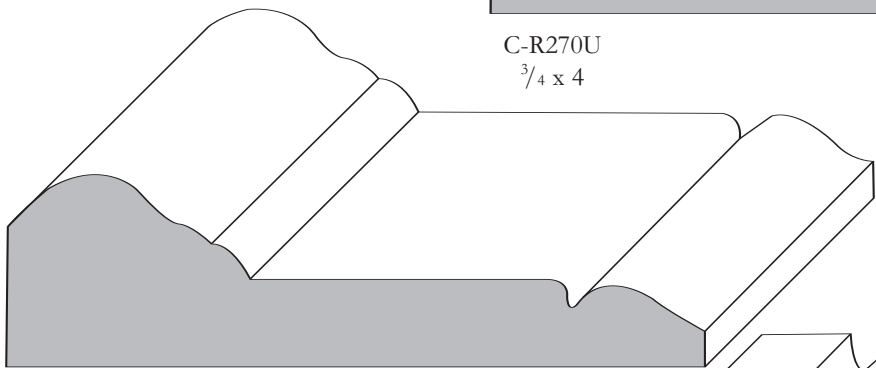

T-WP460
1 x 3 5/8

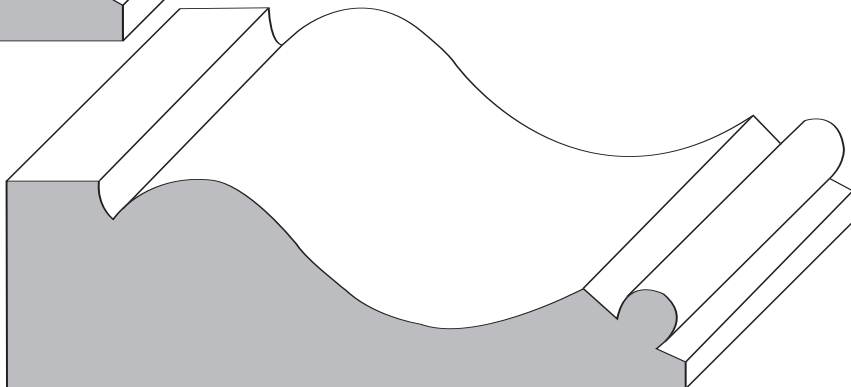

T-WP460
1 x 3 5/8



CASING

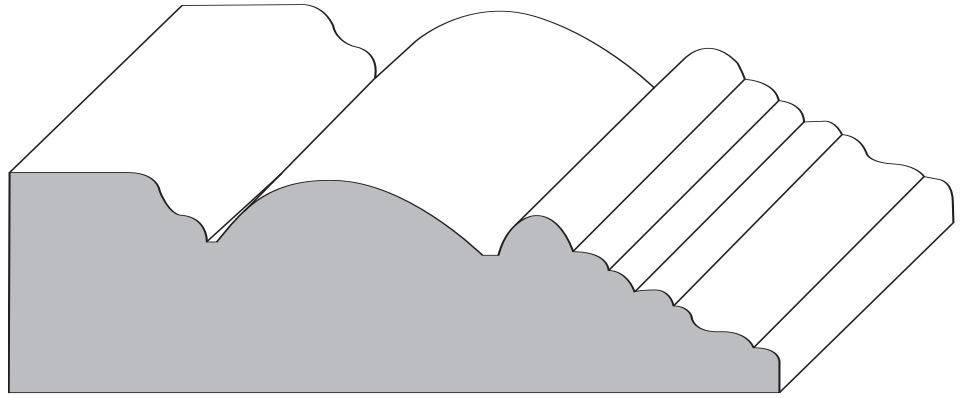

T-WP460
1 x 3⁵/₈

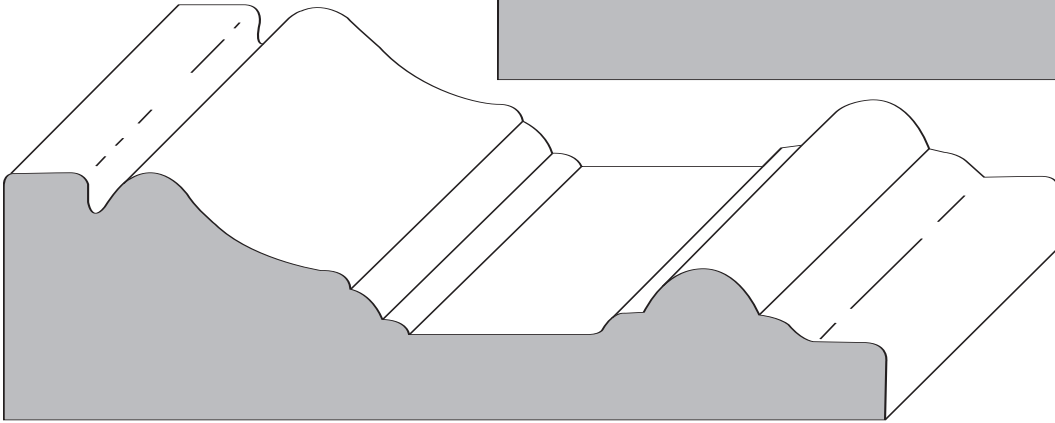

C-ST4-5
1¹/₄ x 4¹/₂

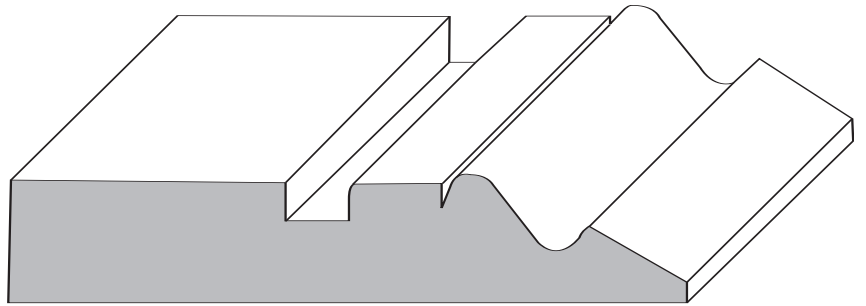

C-L8753
5⁵/₈ x 3¹/₂

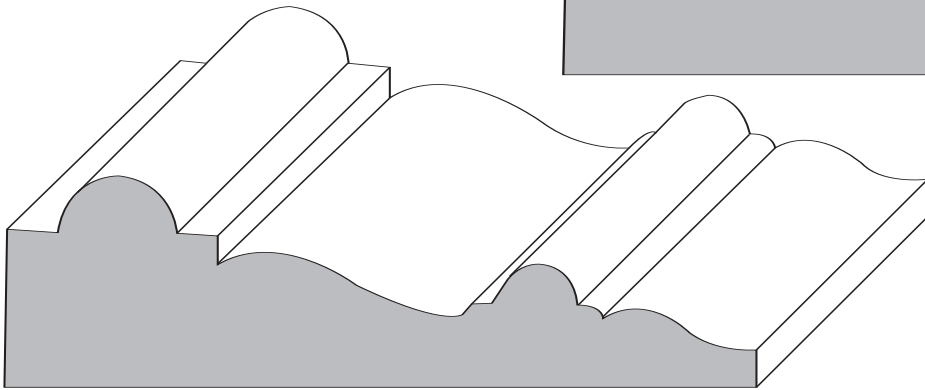

C-RR380
1 x 3⁵/₈

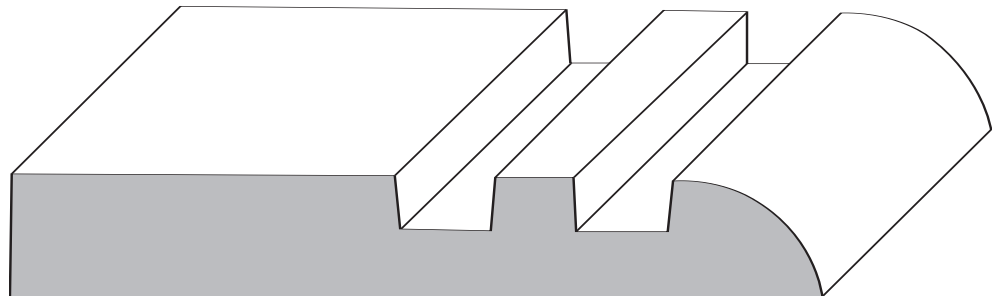

C-MD415
5⁵/₈ x 4¹/₈



CASING

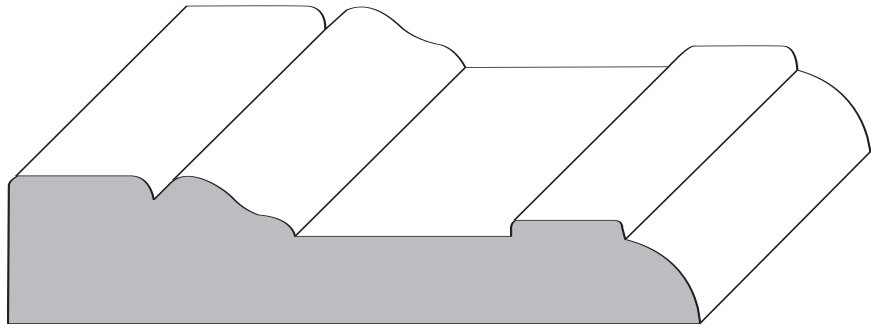

C-NJ128
3/4 x 3⁹/₁₆

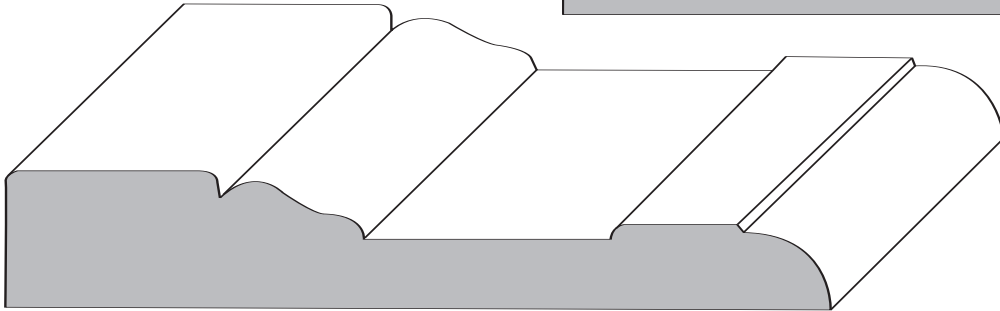

C-DI235
1¹/₁₆ x 4¹/₄

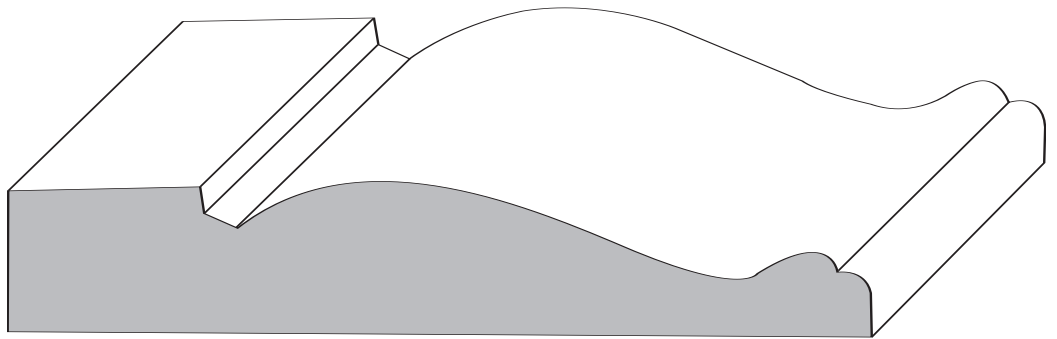

C-SM450
3/4 x 4¹/₂

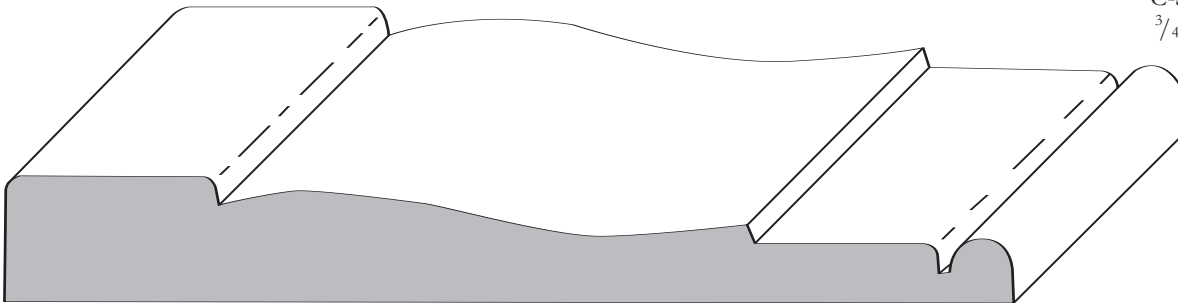

C-PM931
5/8 x 5¹/₄

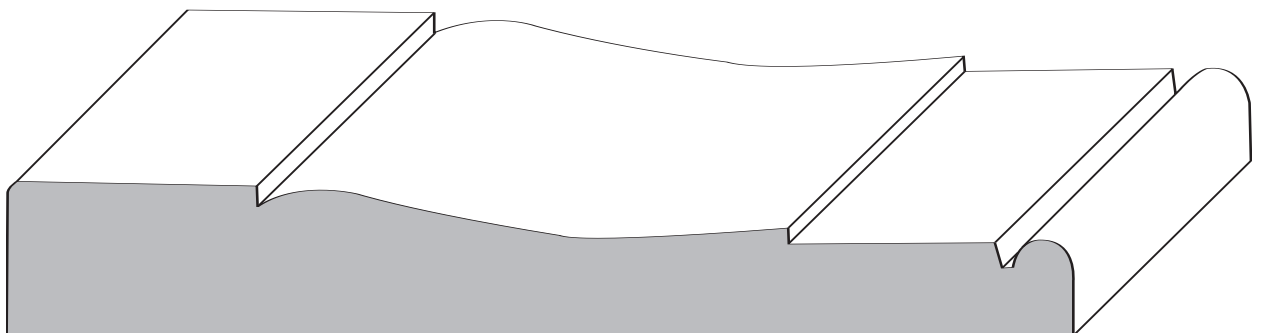

C-SM315
3/4 x 5¹/₂



CASING

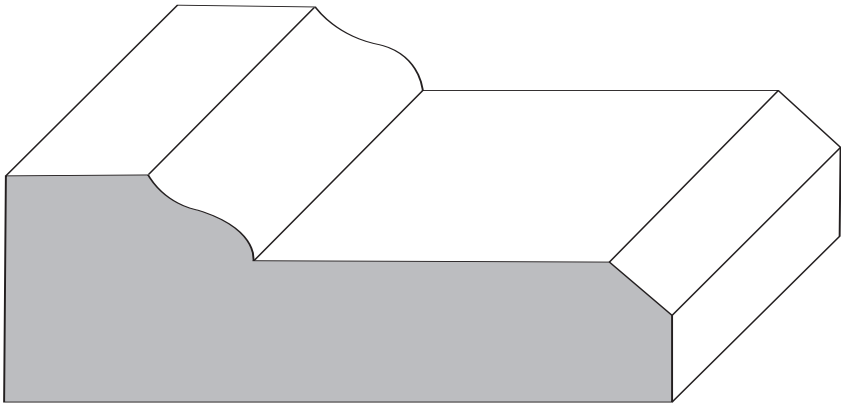

C-PO350
 $1\frac{1}{8} \times 3\frac{1}{2}$

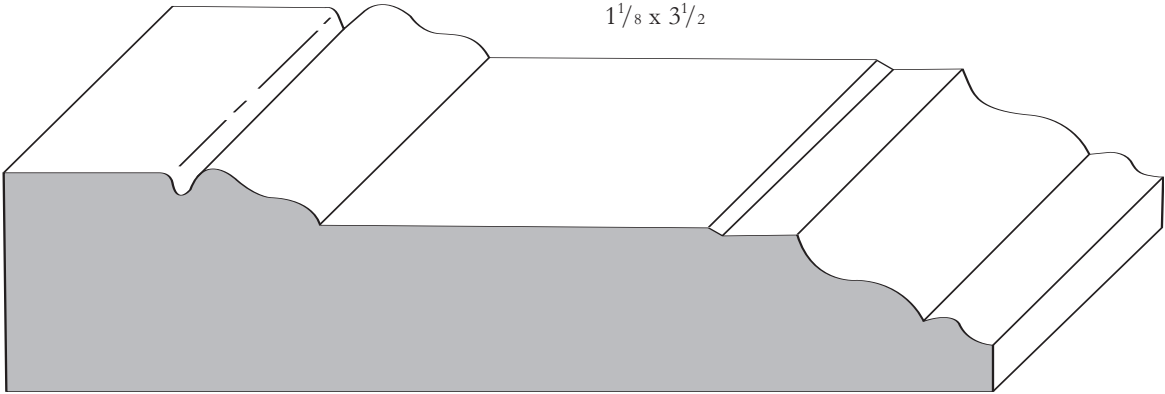

C-TH141
 $1\frac{1}{8} \times 5\frac{1}{8}$

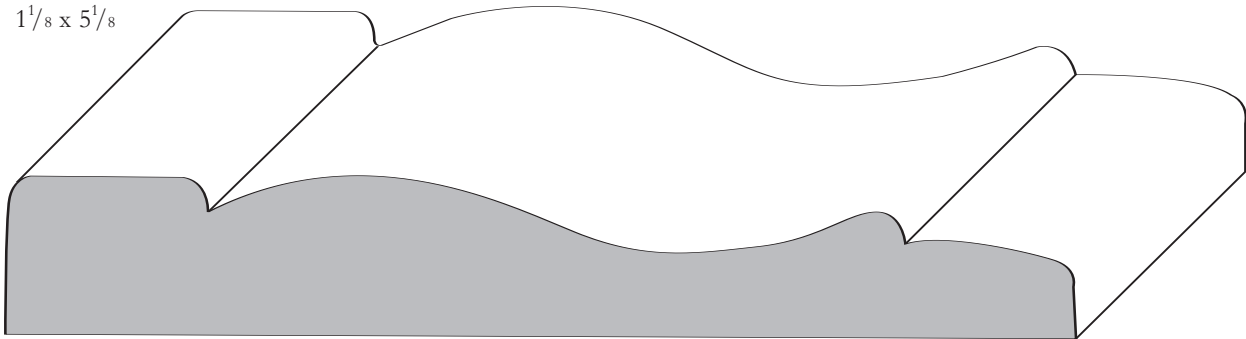

C-PA550
 $\frac{3}{16} \times 5\frac{1}{2}$

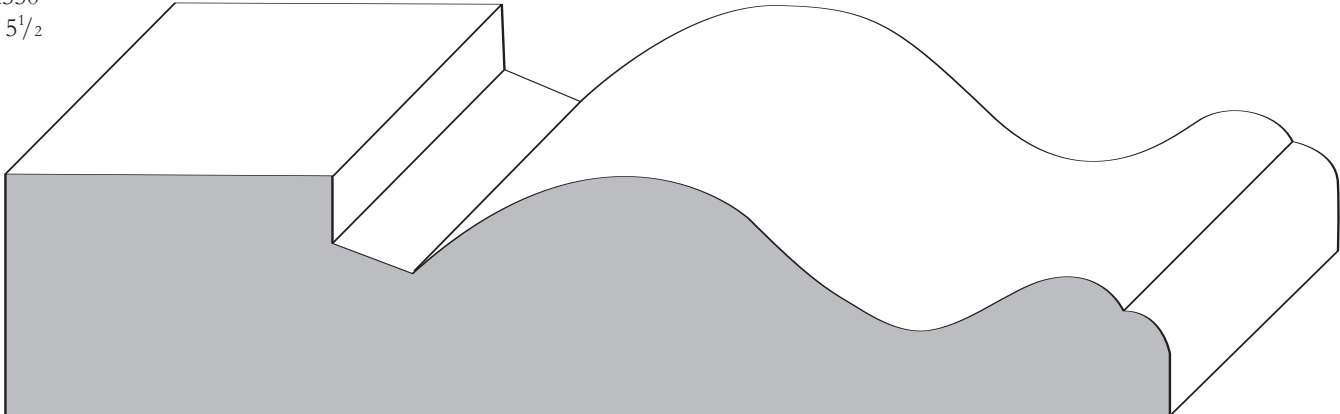

C-SM600
 $1\frac{1}{4} \times 6$



CASING

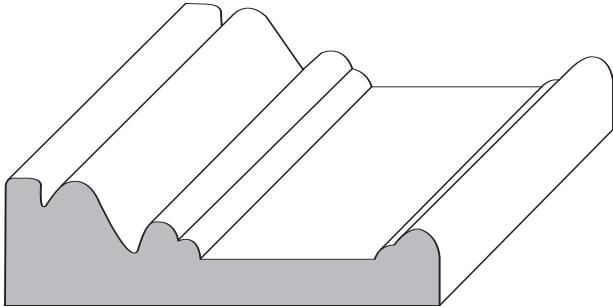

T-RB1
5/8 x 2 1/4

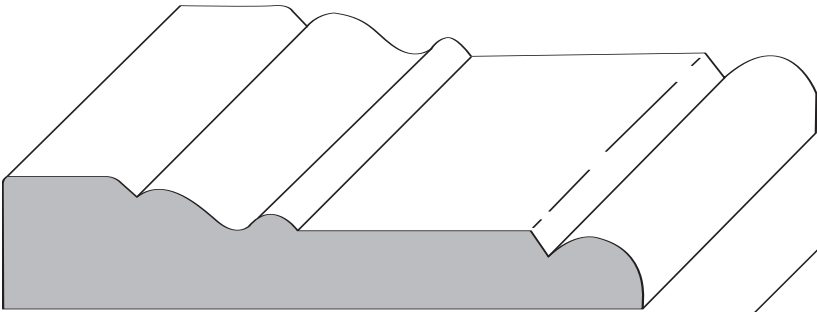

C-HERIT
11/16 x 3 1/4

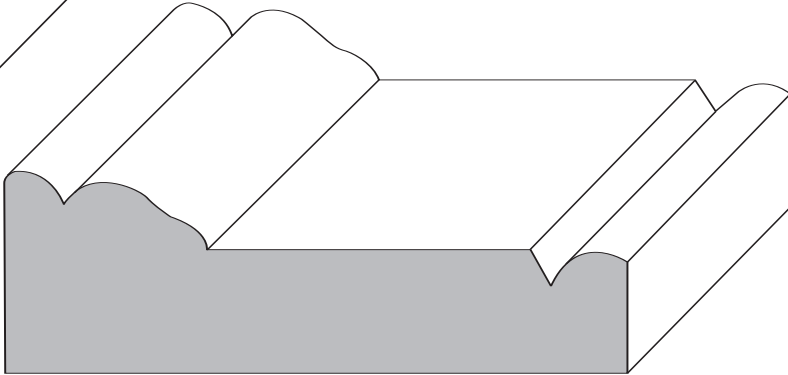

C-DYKSP
1 x 3 1/4

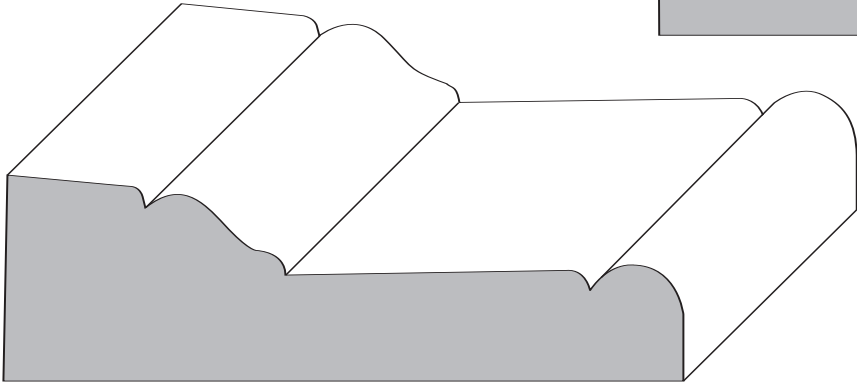

C-SSD97
1 1/16 x 3 5/8

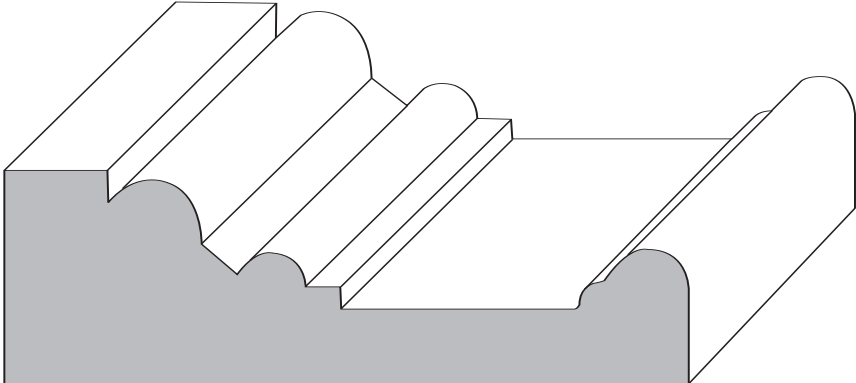

C-P2575
1 1/8 x 3 1/2



CASING

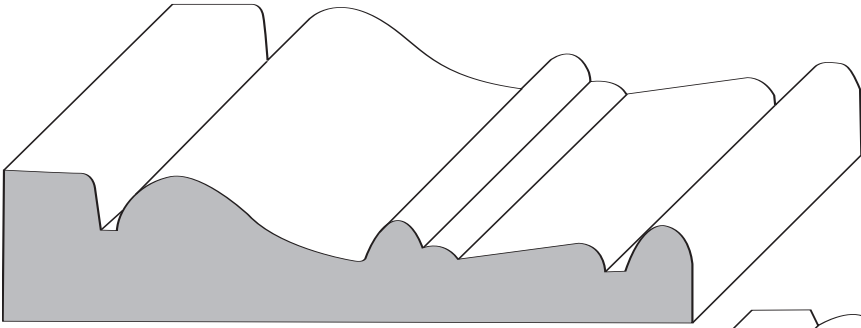

C-SSD97
1¹/₁₆ x 3⁵/₈

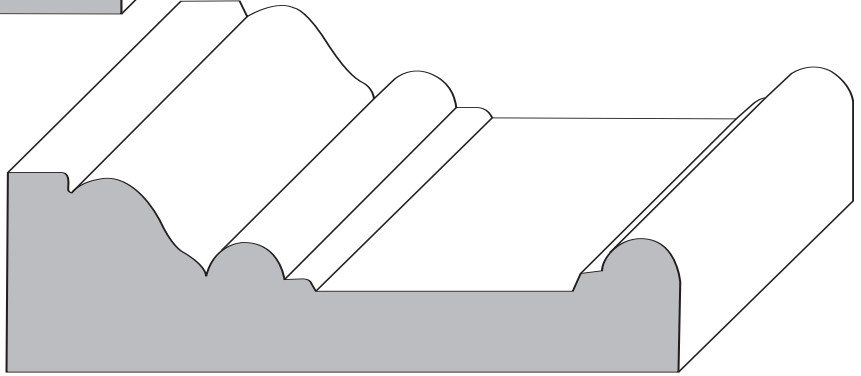

T-RB300
1 x 3¹/₂

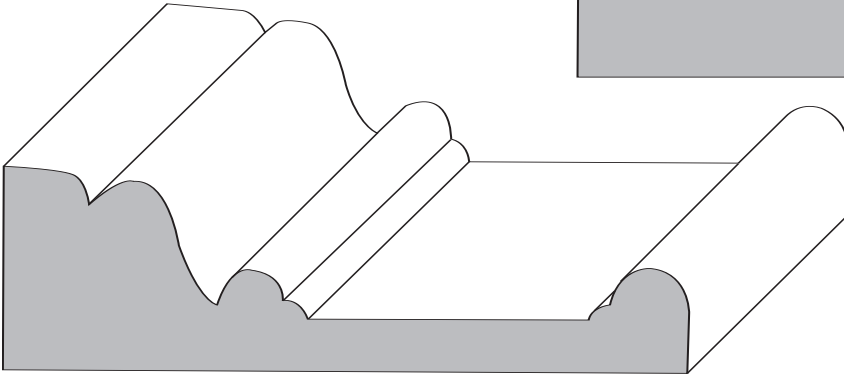

C-DHOWE
1 x 3¹/₂

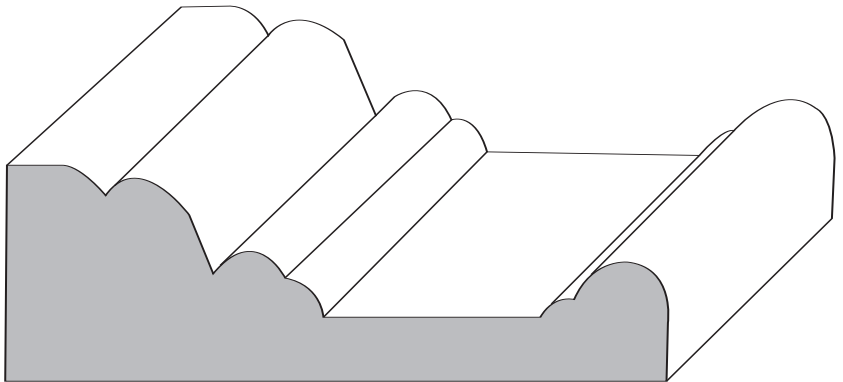

C-TT302
1¹/₁₆ x 3³/₈

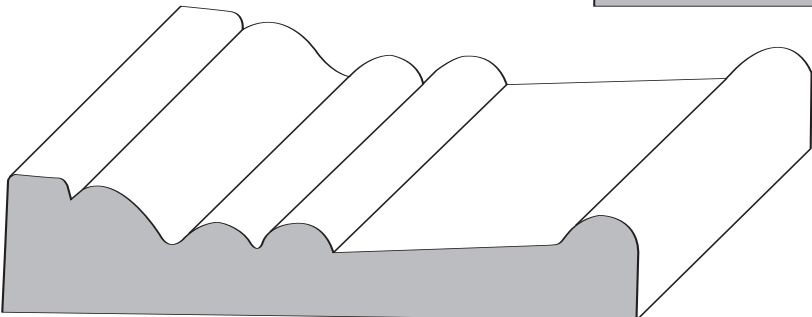

C-HSD-1
1¹¹/₁₆ x 3¹/₄



CASING

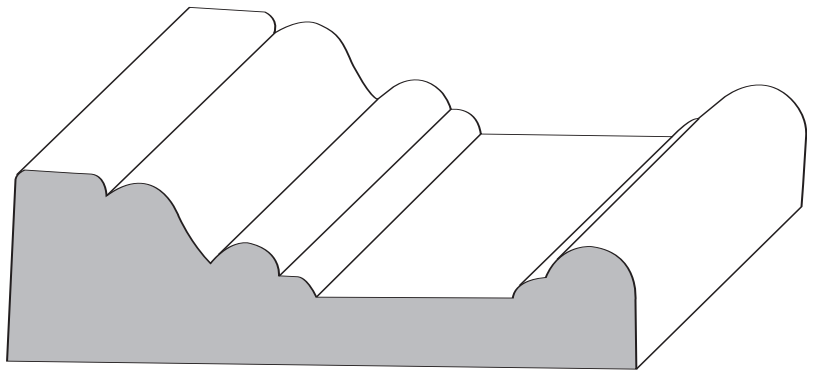

C-VS300
1 x 3/4

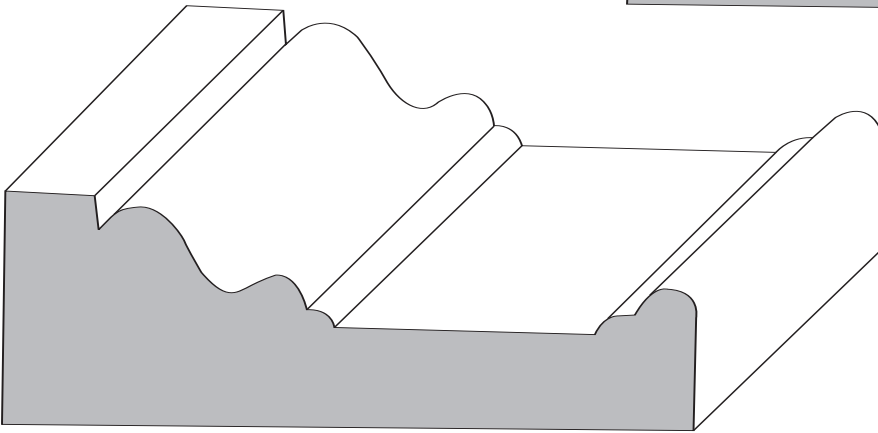

C-EC1
1 x 3/2

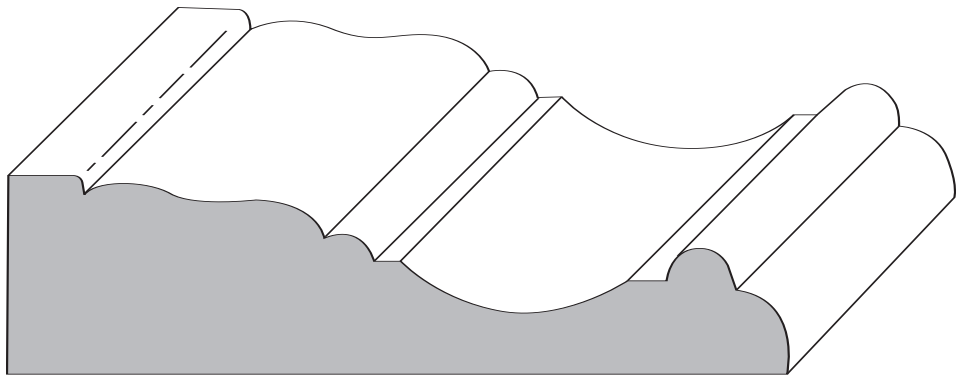

C-SSD97
1 1/16 x 3 5/8

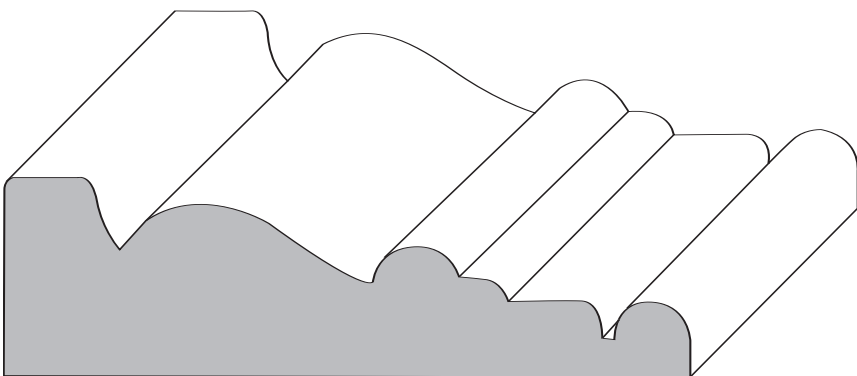

C-NJ119
1 x 3/2

CASING

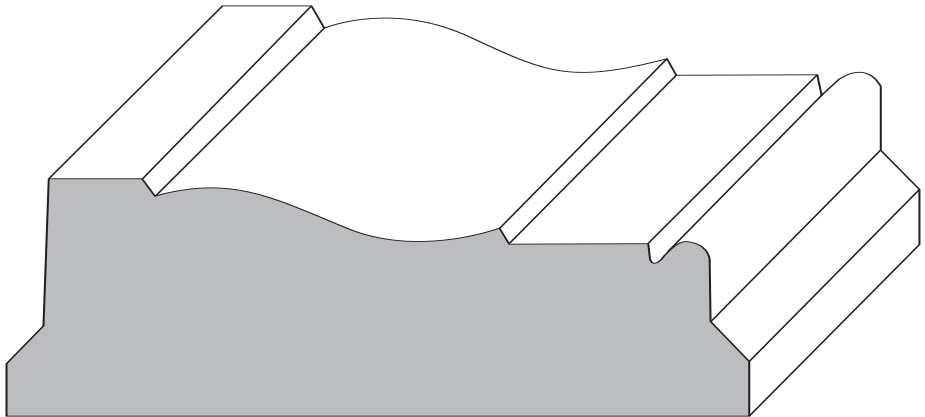

C-HA378
1³/₁₆ x 3⁷/₈

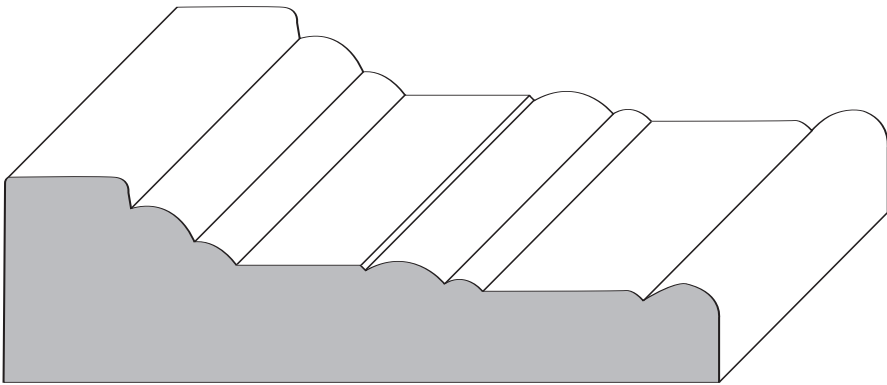

C-WP470
1¹/₁₆ x 3³/₄

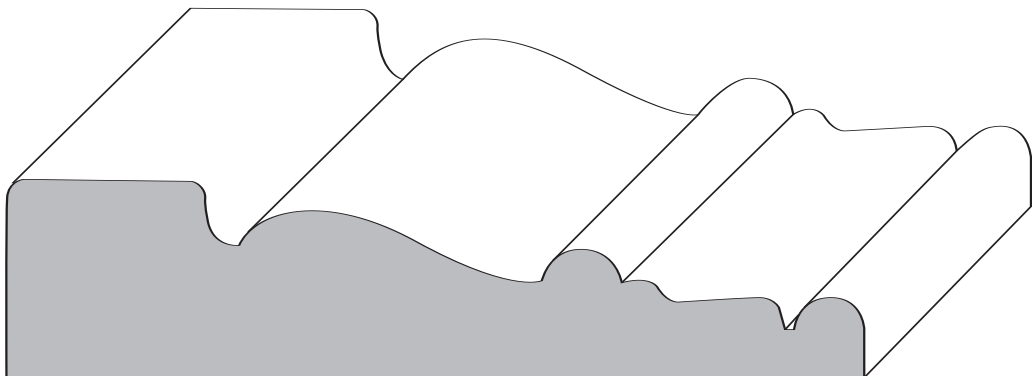

C-NJ419
1 x 4³/₈

CASING

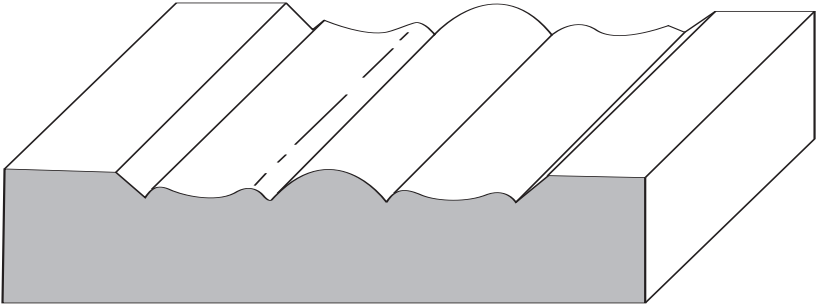

C-SS281
 $\frac{7}{8} \times 3\frac{1}{2}$

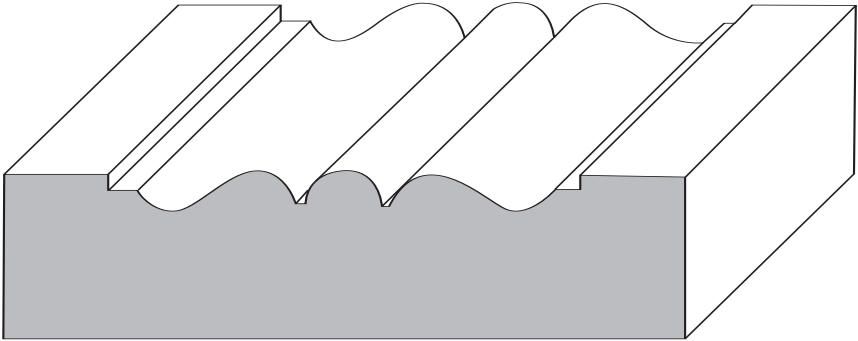

C-RR272
 $\frac{3}{4} \times 4$

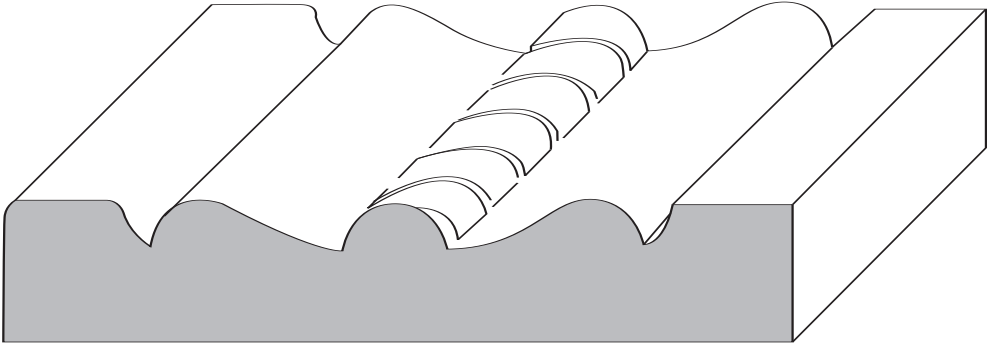

C-RR272
 $\frac{3}{4} \times 4$

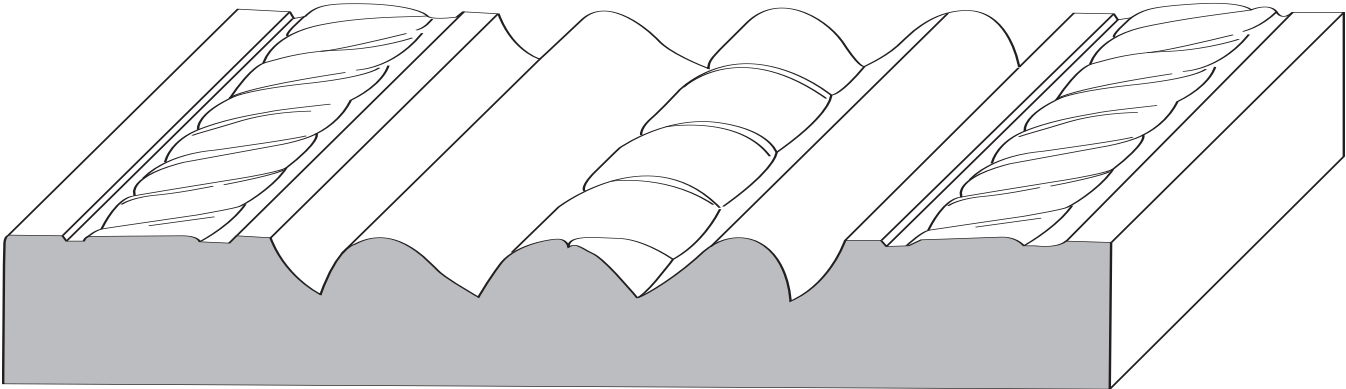

C-RR271
 $\frac{3}{4} \times 5\frac{3}{4}$



CASING

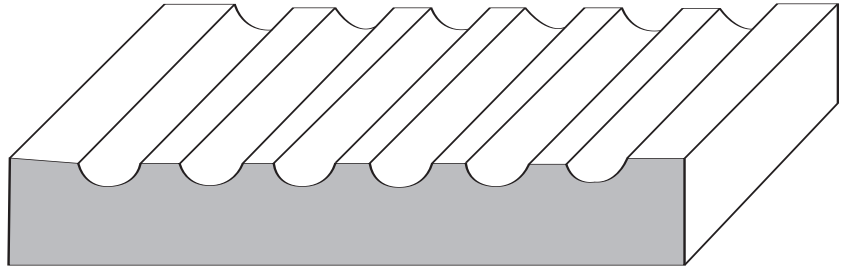

C-B1002
1/2 x 3⁹/₁₆

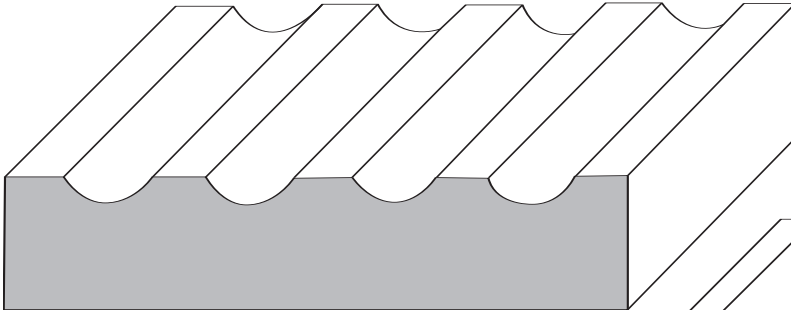

C-FLUTT
1/16 x 3¹/₄

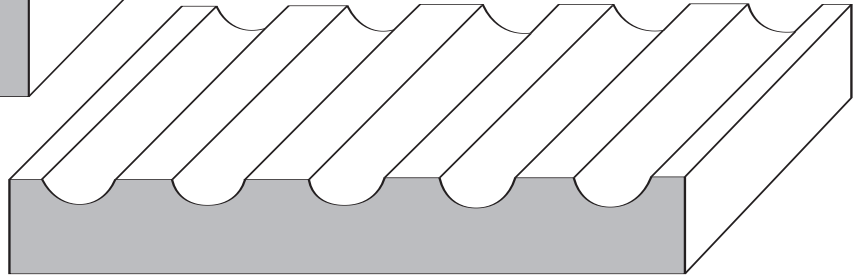

T-SL311
1/2 x 3¹/₂

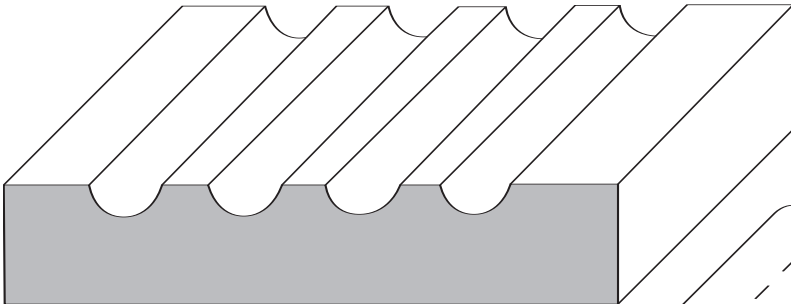

C-RRLO5
5/8 x 3¹/₄

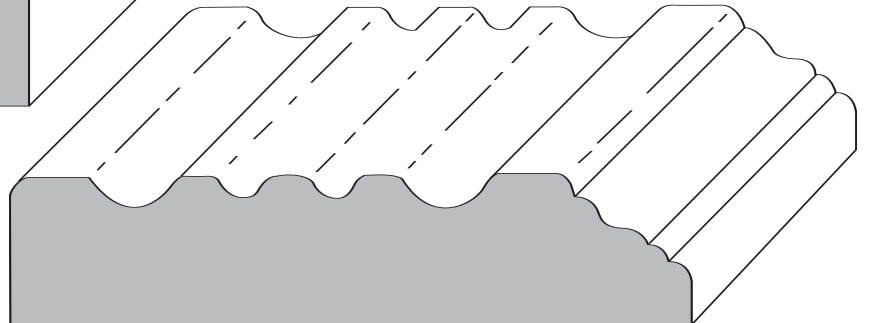

C-HI312
3/4 x 3¹/₂

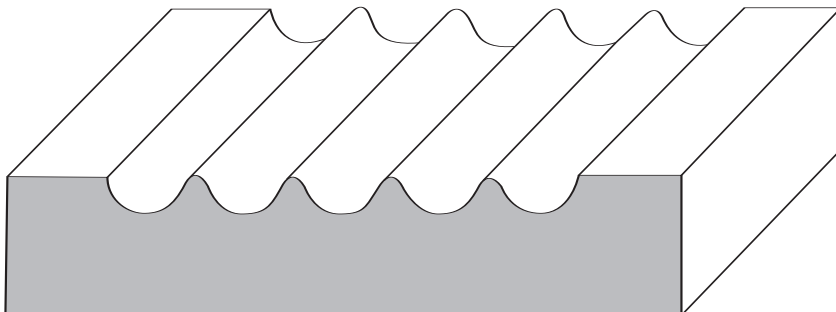

C-CL312
3/4 x 3¹/₂



CASING

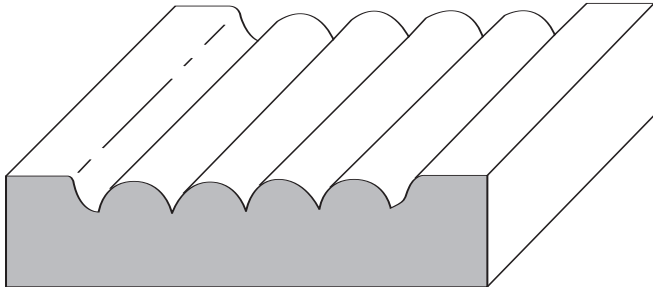

C-RR255
 $\frac{9}{16} \times 2\frac{1}{2}$

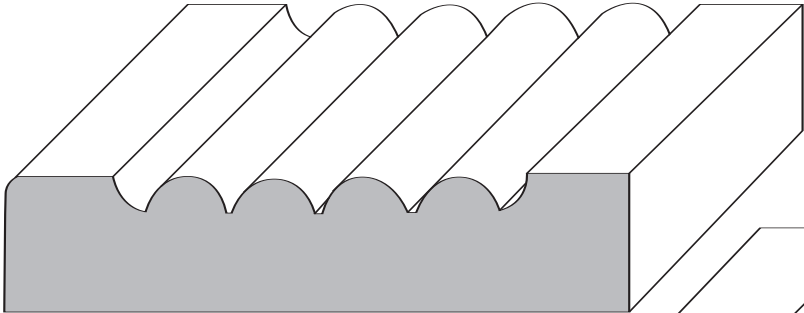

C-RR260
 $\frac{11}{16} \times 3\frac{1}{4}$

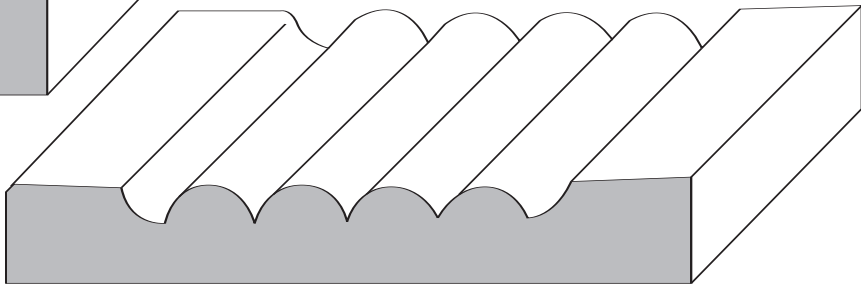

C-M15
 $\frac{1}{2} \times 3\frac{1}{2}$

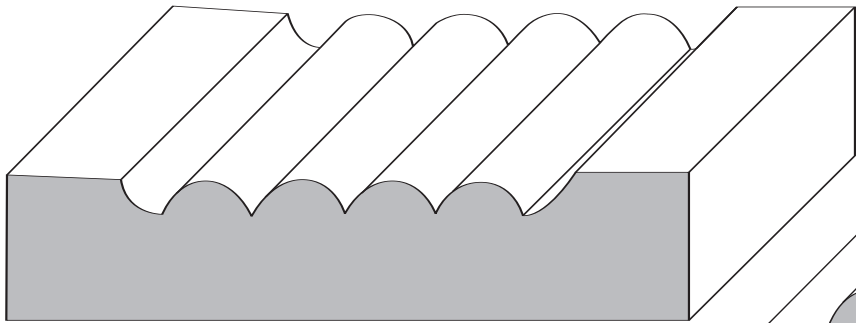

C-RAM15
 $\frac{3}{4} \times 3\frac{1}{2}$

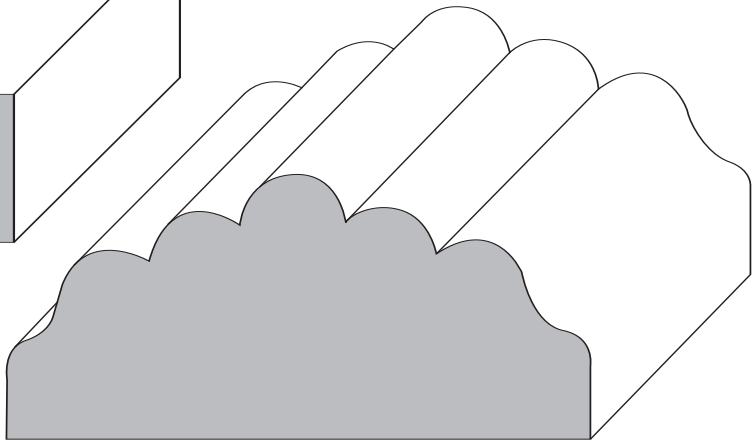

C-RR300
 $1\frac{5}{16} \times 3$

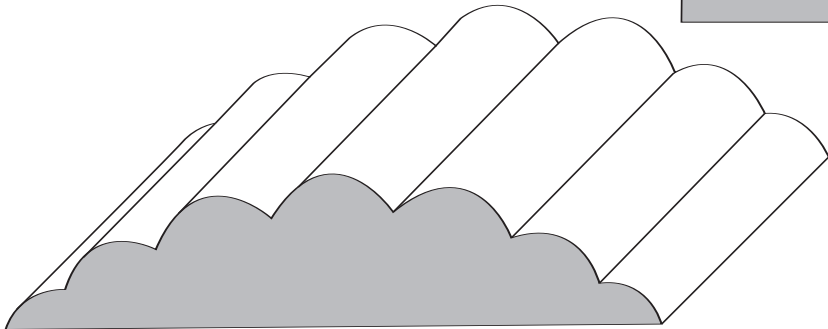

C-M14
 $\frac{5}{16} \times 3\frac{3}{8}$



CASING

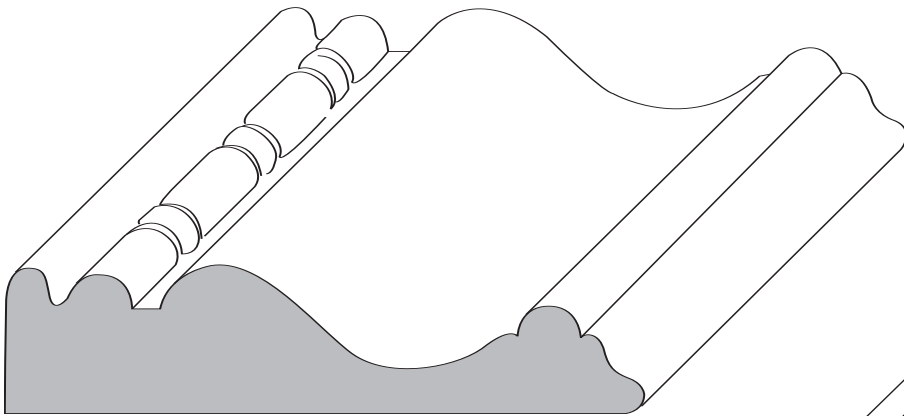

C-RR265
 $\frac{3}{4} \times 3\frac{1}{4}$

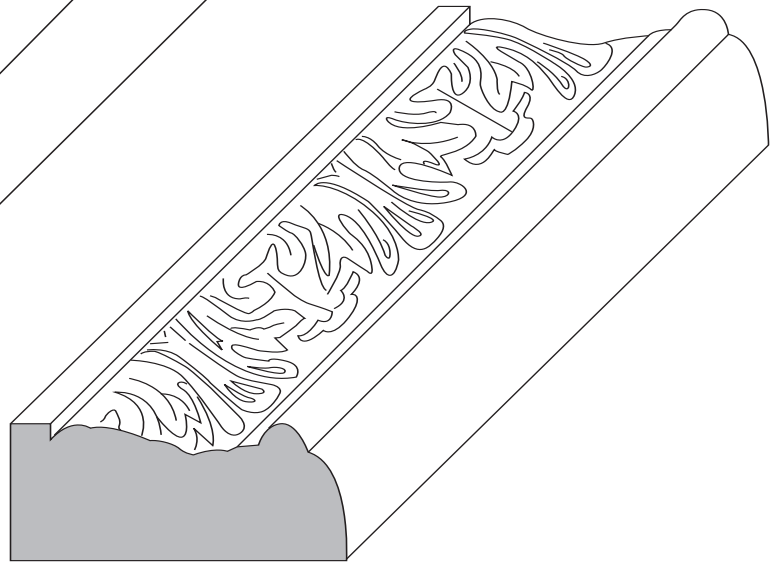

C-EM615
 $\frac{3}{4} \times 1\frac{3}{4}$

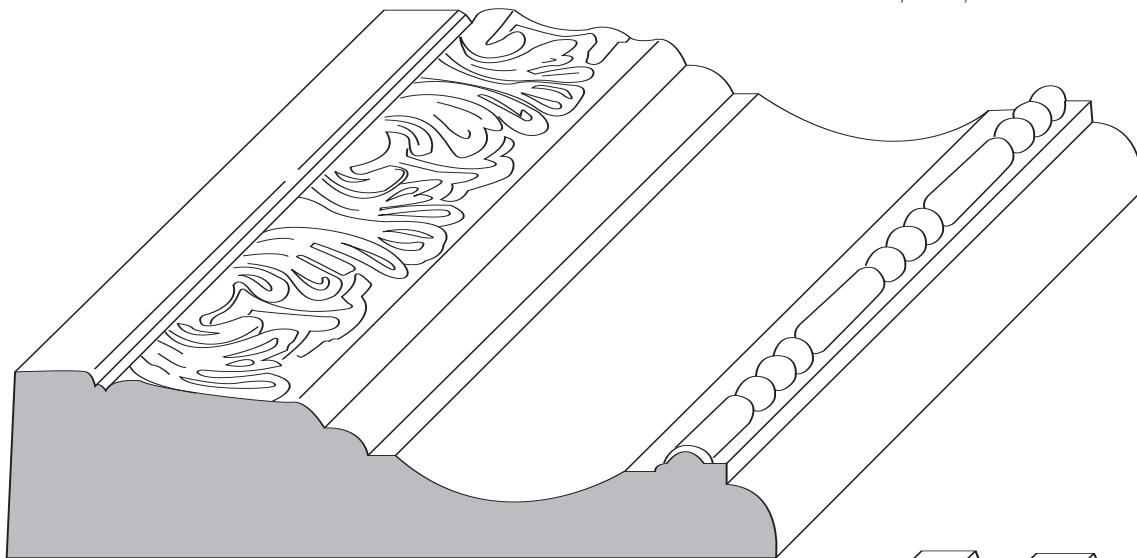

C-DS408
1 x 4

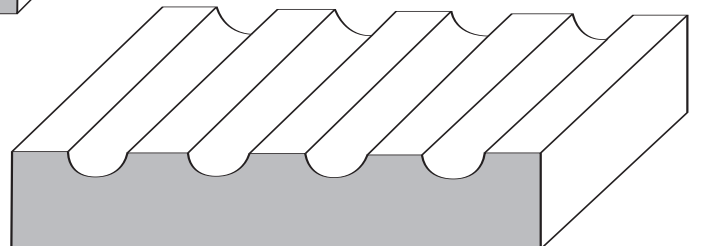

C-EC14F
 $\frac{5}{8} \times 3\frac{1}{4}$

BASE

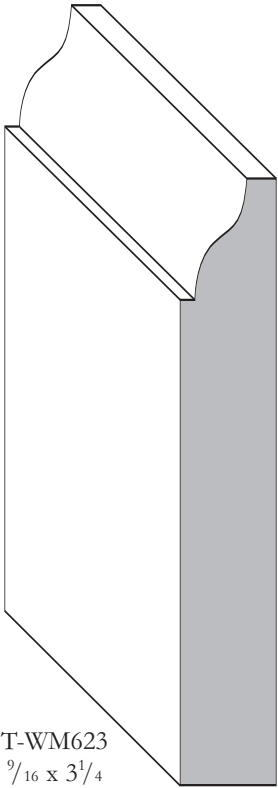

T-WM623
9/16 x 3 1/4

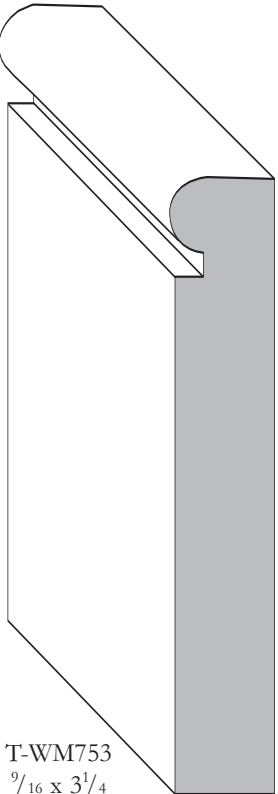

T-WM753
9/16 x 3 1/4

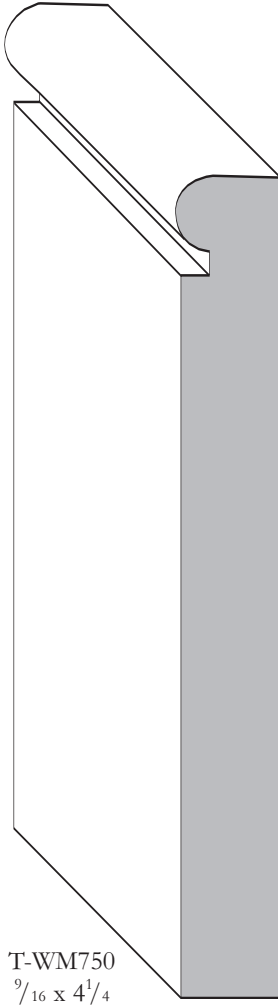

T-WM750
9/16 x 4 1/4

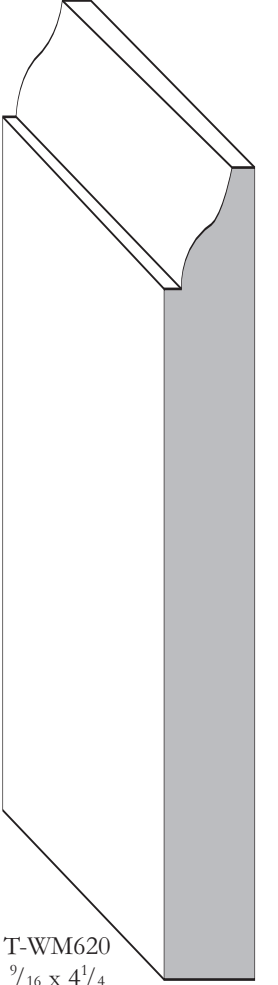

T-WM620
9/16 x 4 1/4

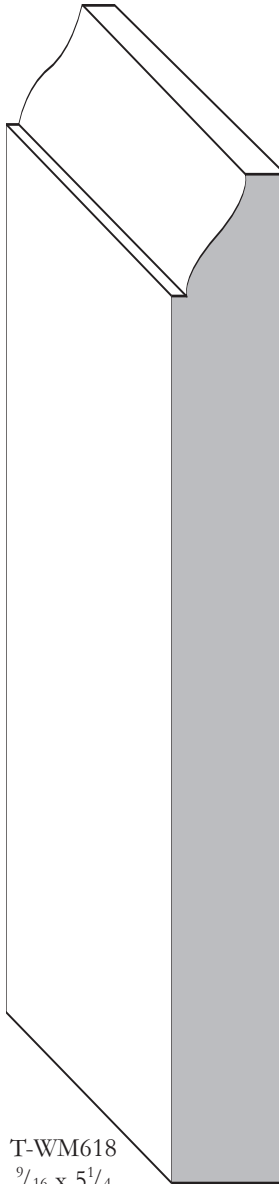

T-WM618
9/16 x 5 1/4

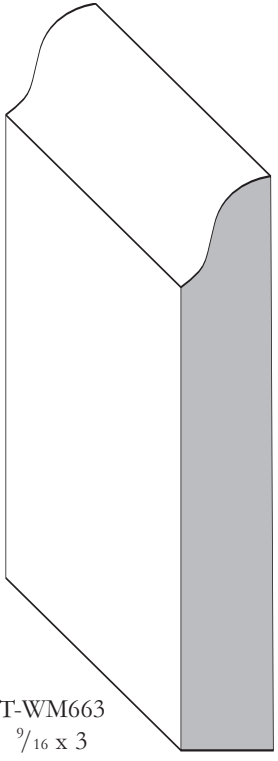

T-WM663
9/16 x 3

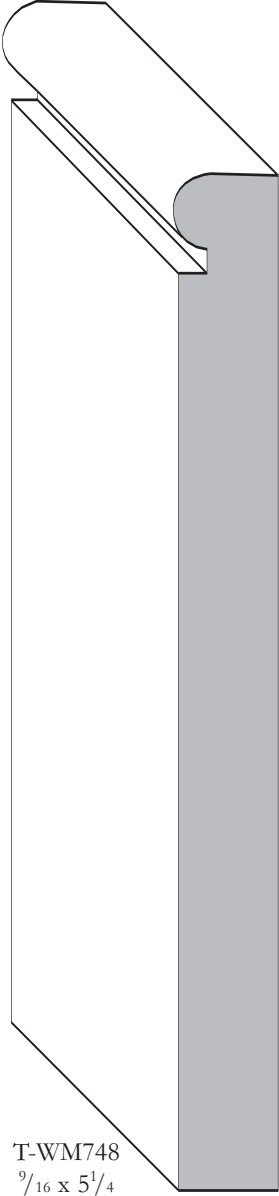

T-WM748
9/16 x 5 1/4



BASE

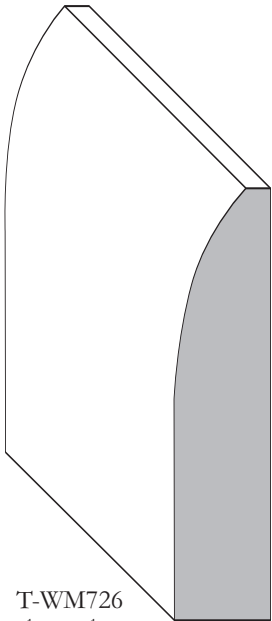

T-WM726
 $\frac{1}{2} \times 2\frac{1}{4}$

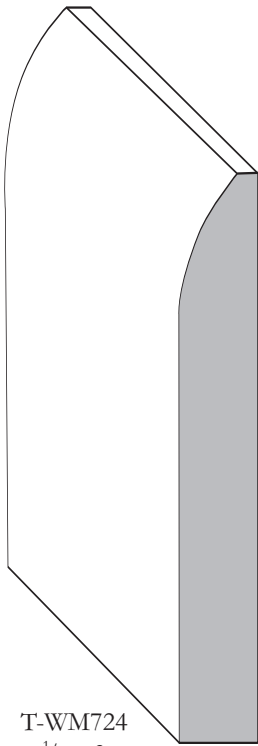

T-WM724
 $\frac{1}{2} \times 3$

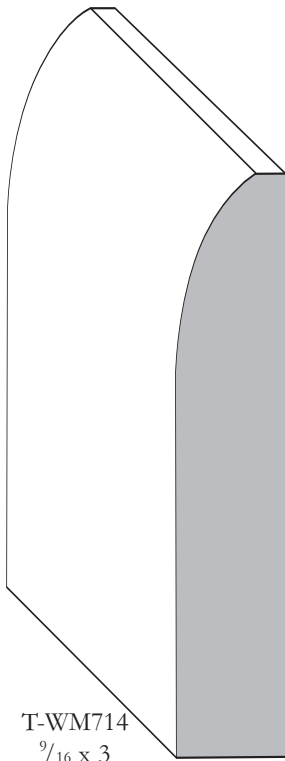

T-WM714
 $\frac{9}{16} \times 3$

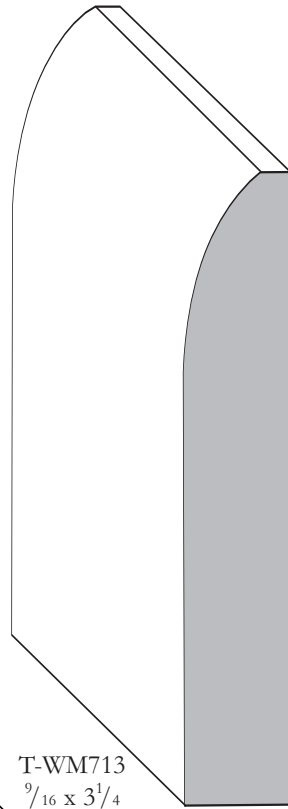

T-WM713
 $\frac{9}{16} \times 3\frac{1}{4}$

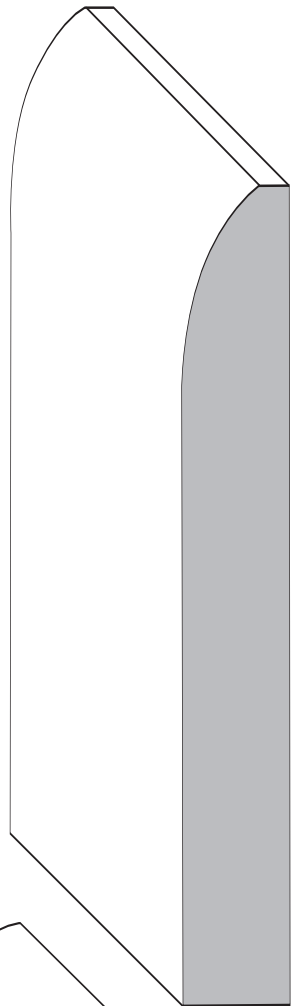

T-WM710
 $\frac{9}{16} \times 4\frac{1}{4}$

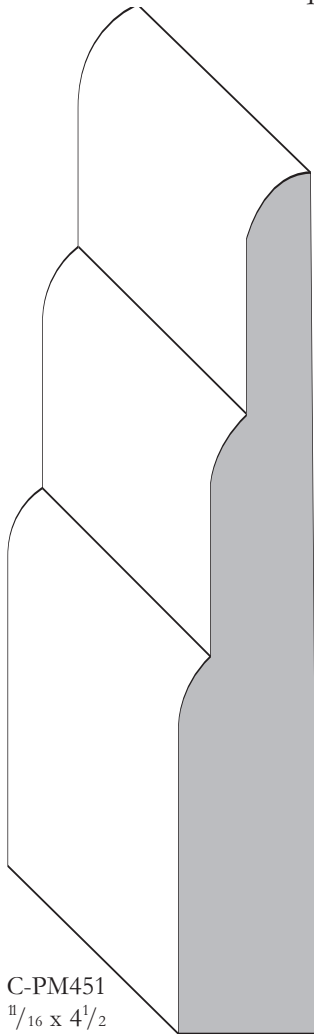

C-PM451
 $\frac{11}{16} \times 4\frac{1}{2}$

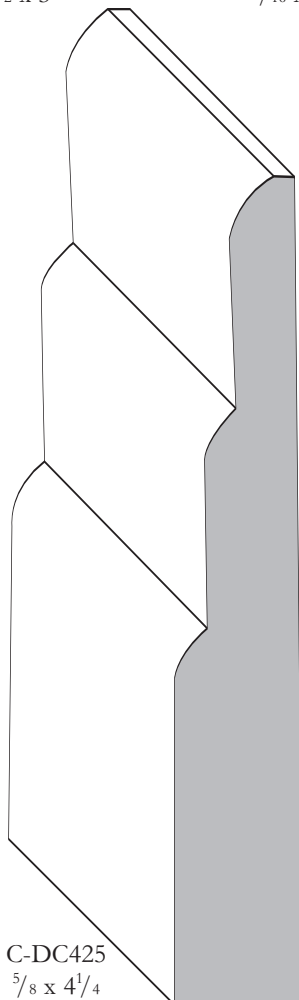

C-DC425
 $\frac{5}{8} \times 4\frac{1}{4}$

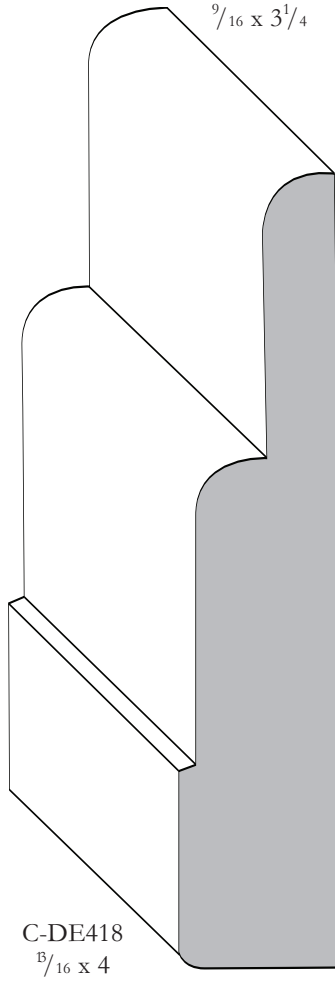

C-DE418
 $\frac{5}{16} \times 4$

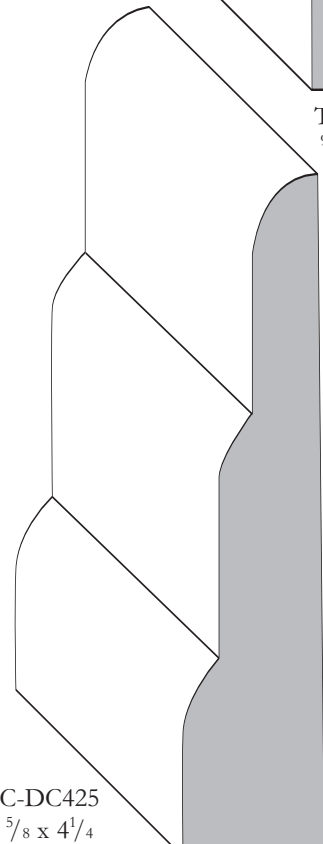

C-DC425
 $\frac{5}{8} \times 4\frac{1}{4}$



BASE

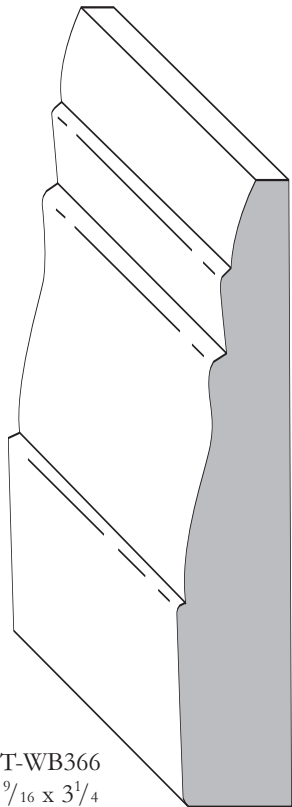
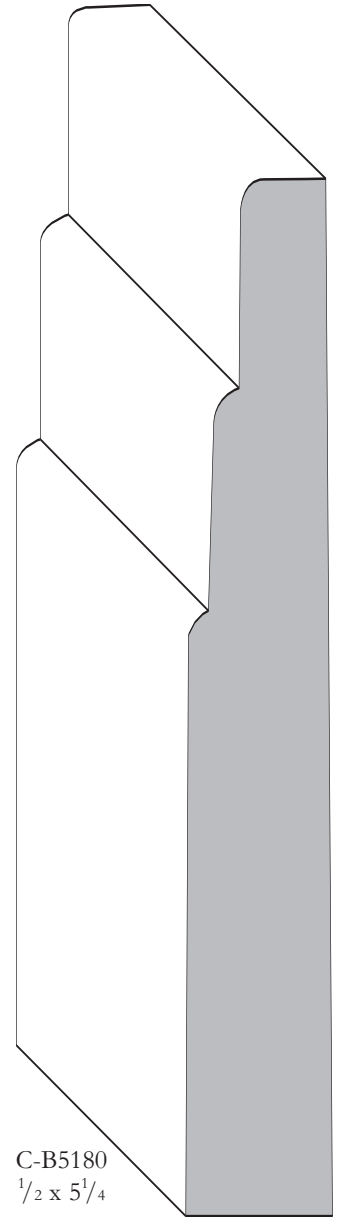
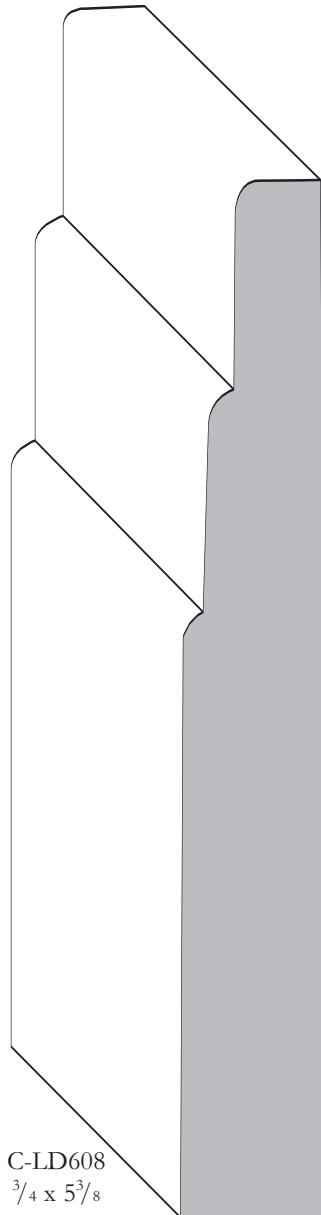
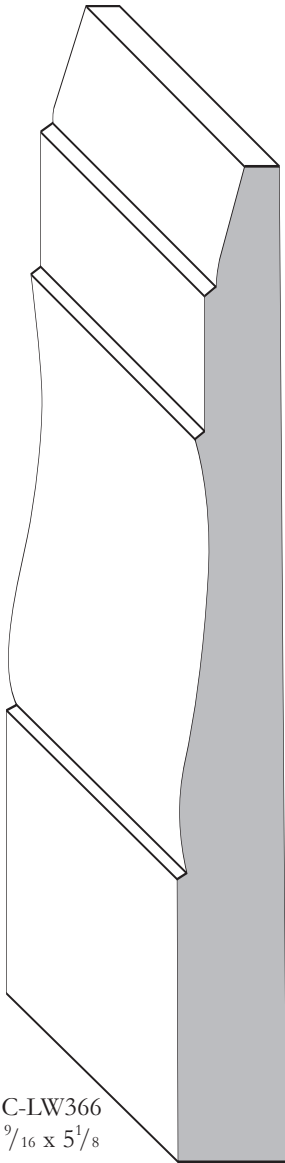
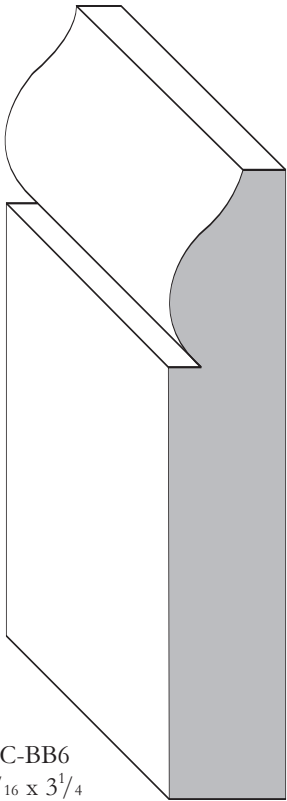

BASE

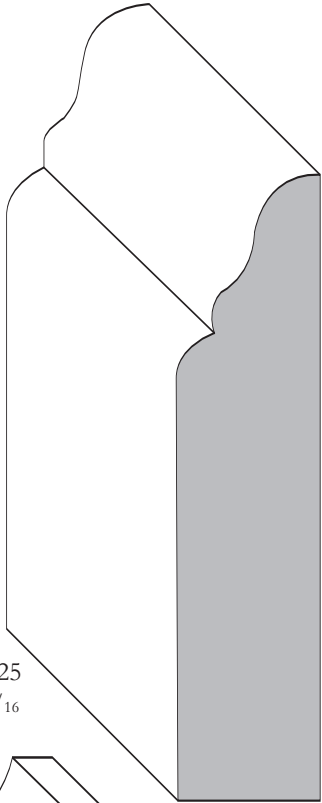

C-FM325
 $\frac{3}{4} \times 3\frac{3}{16}$

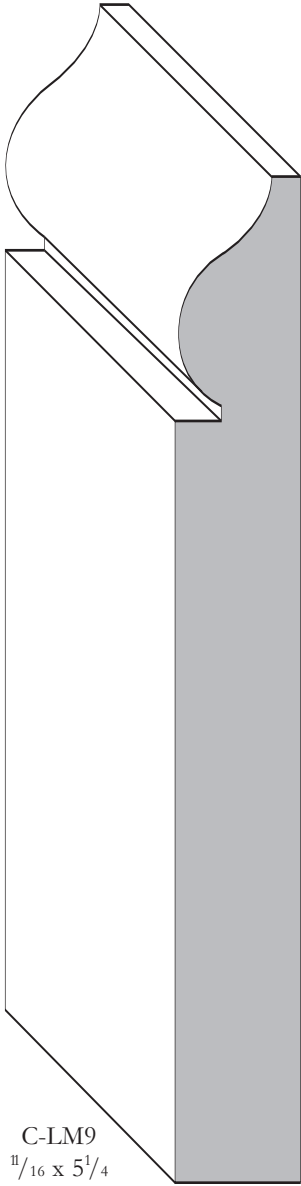

C-LM9
 $\frac{11}{16} \times 5\frac{1}{4}$

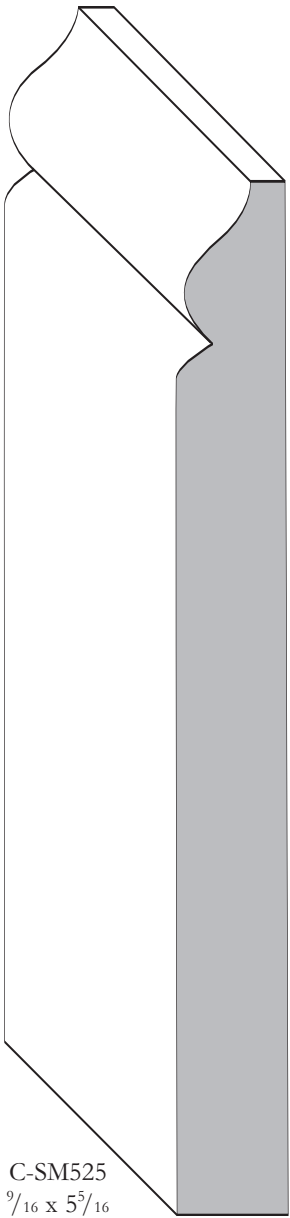

C-SM525
 $\frac{9}{16} \times 5\frac{5}{16}$

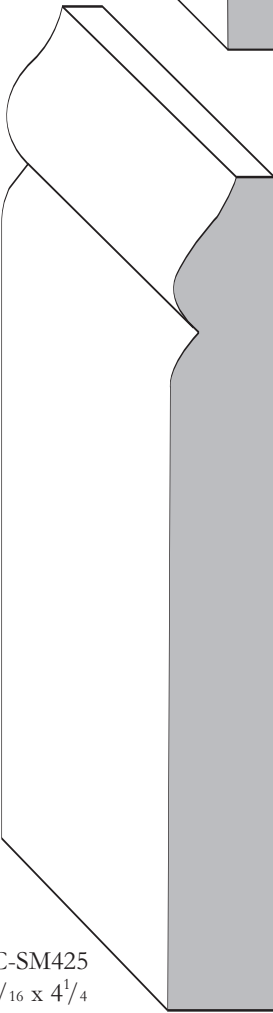

C-SM425
 $\frac{9}{16} \times 4\frac{1}{4}$

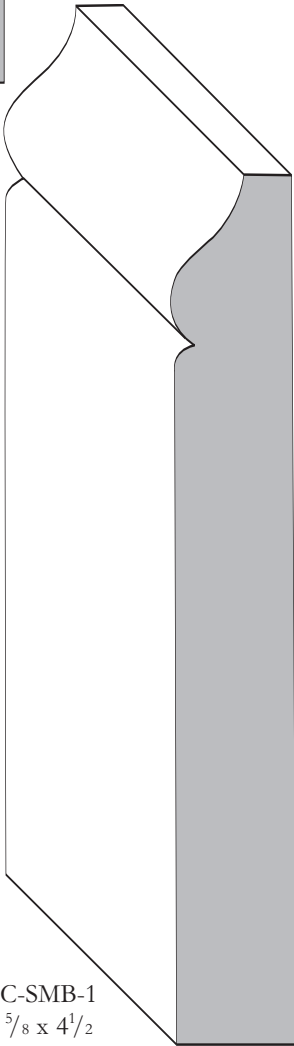

C-SMB-1
 $\frac{5}{8} \times 4\frac{1}{2}$



BASE

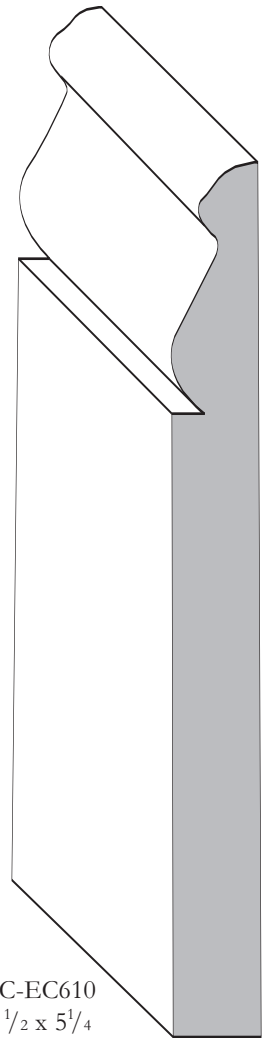
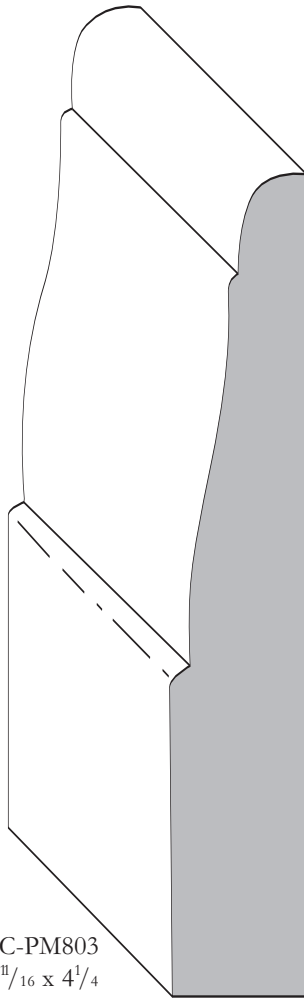
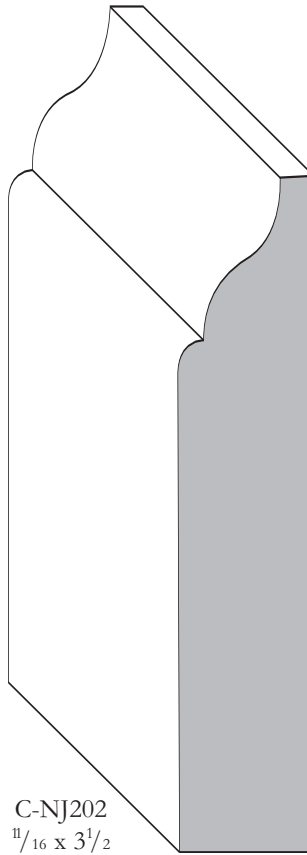
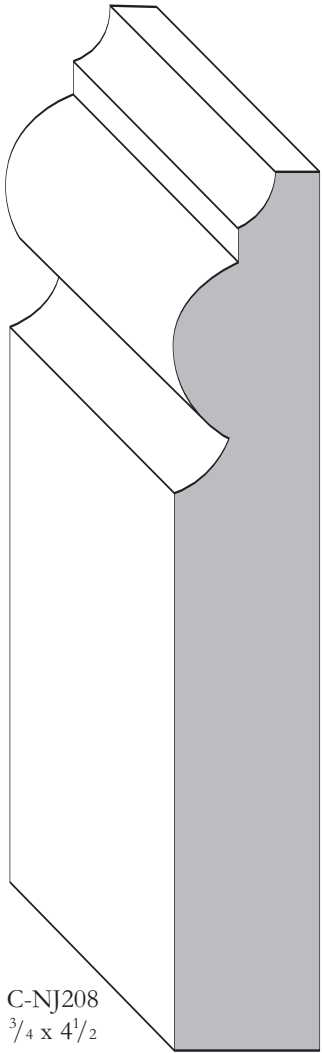

BASE

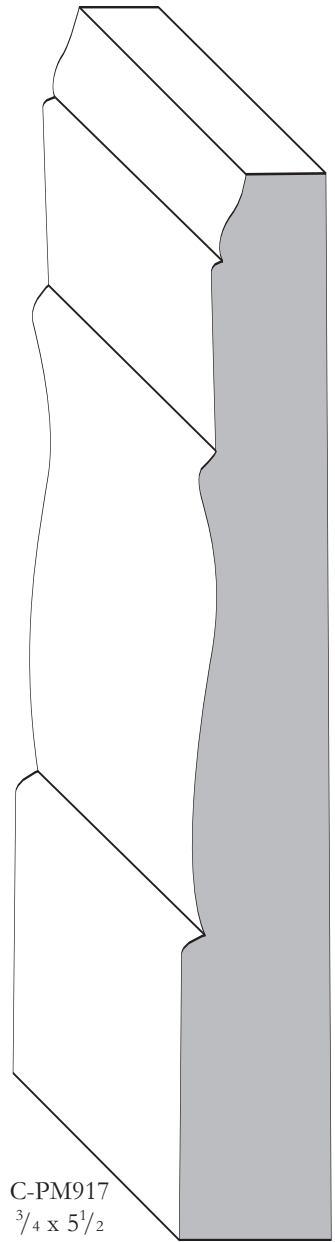
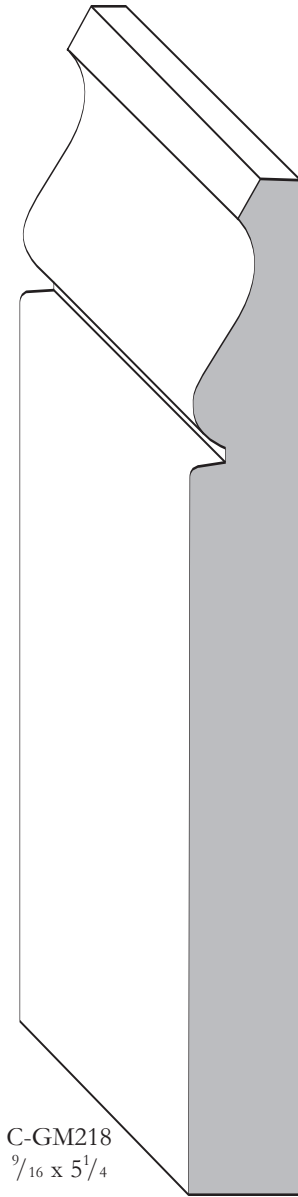
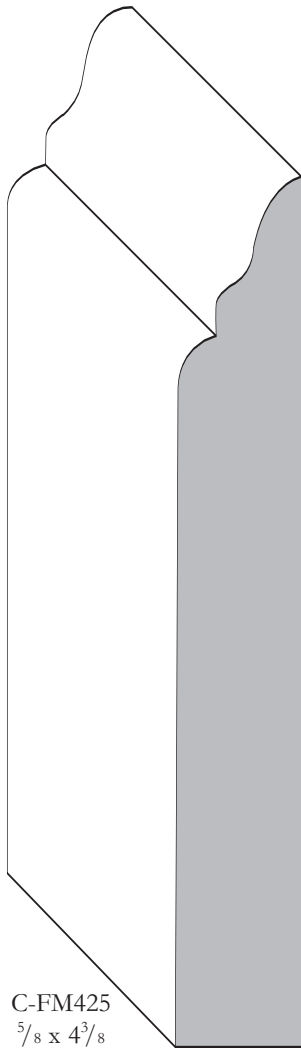
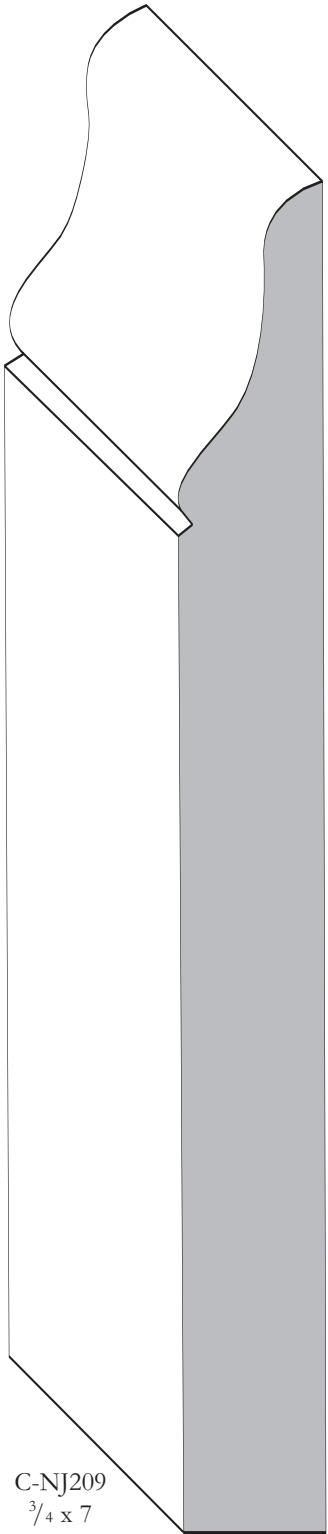

BASE

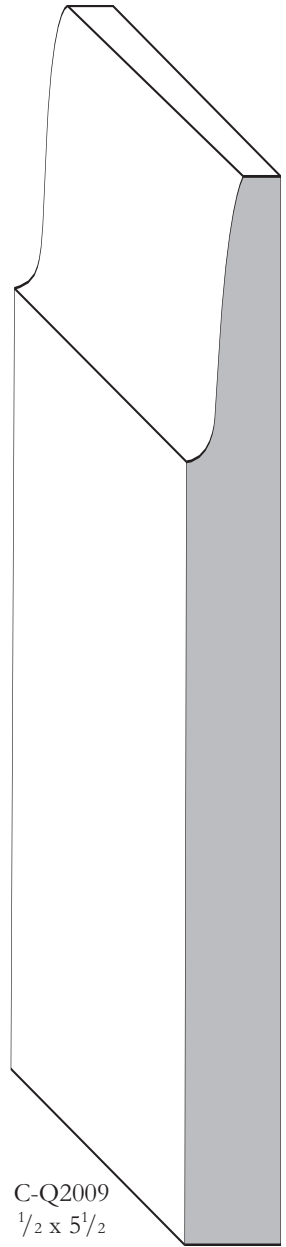
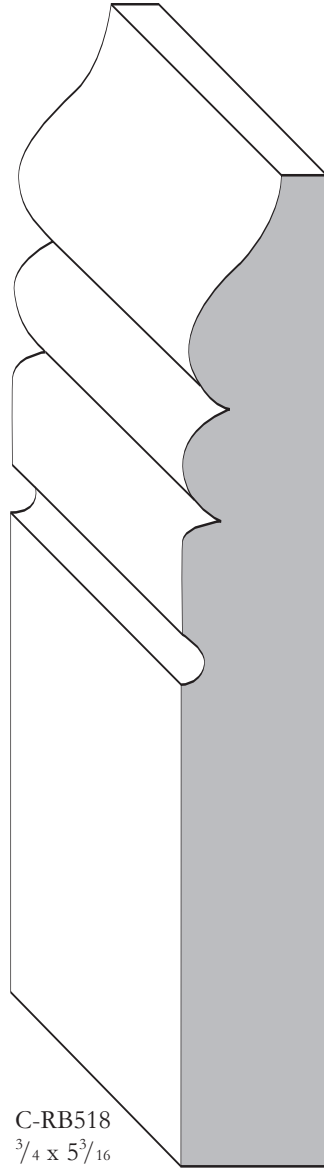
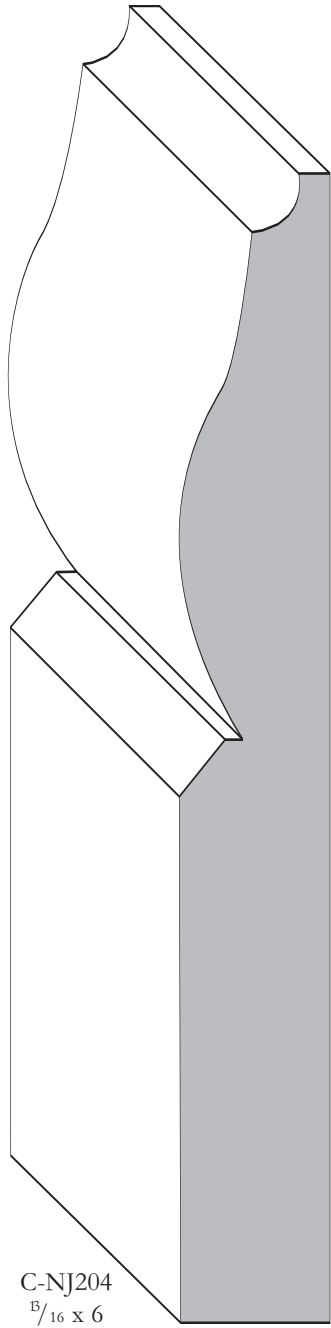
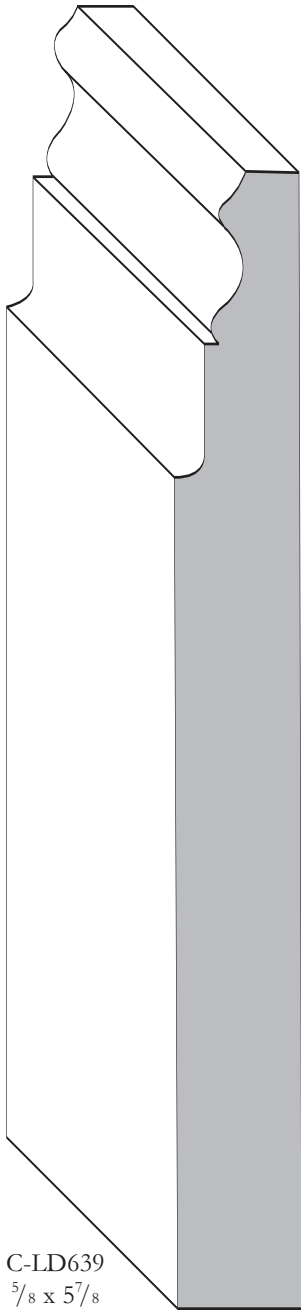

BASE

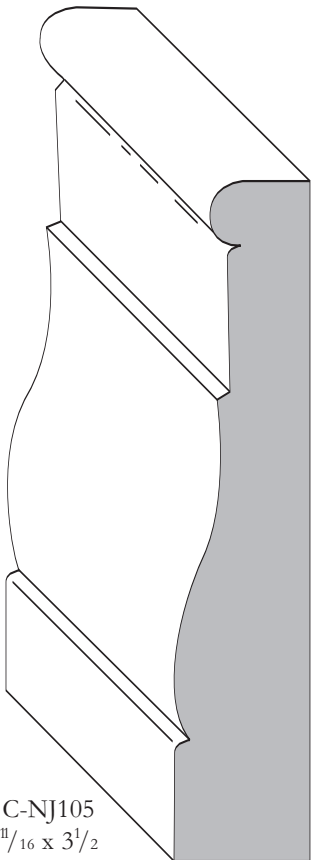
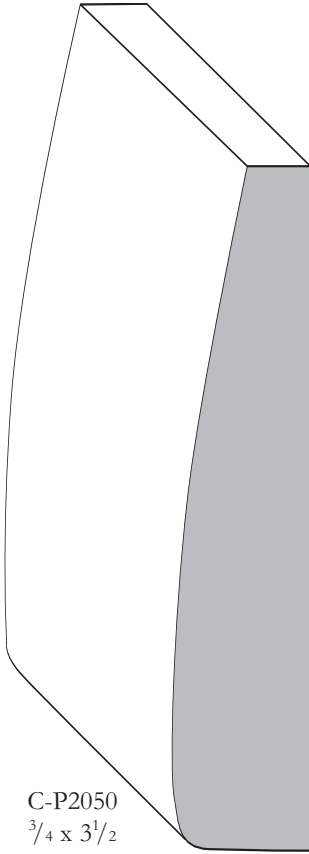
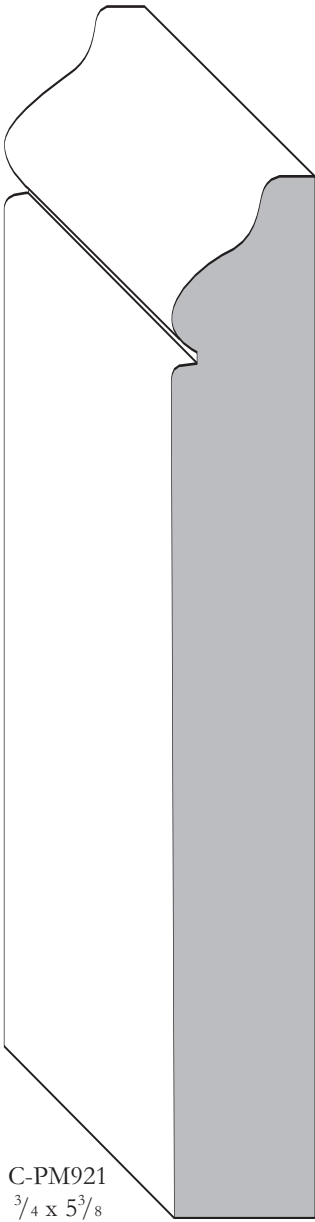
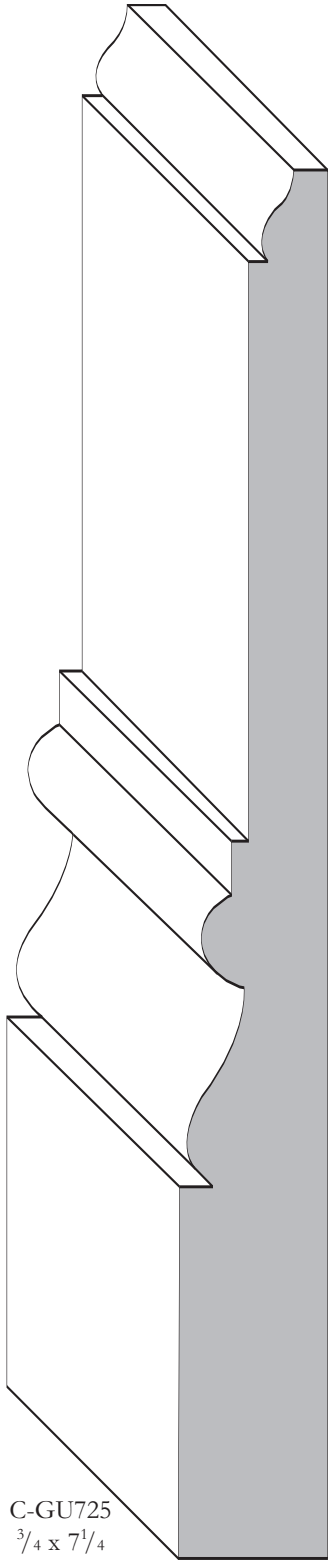

BASE

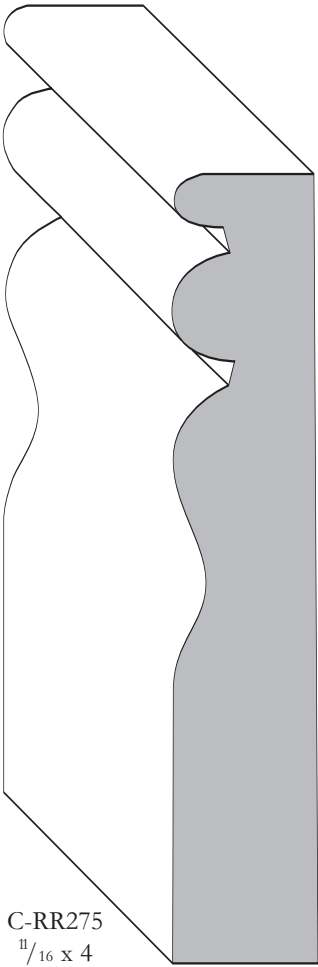

C-RR275
 $\frac{11}{16} \times 4$

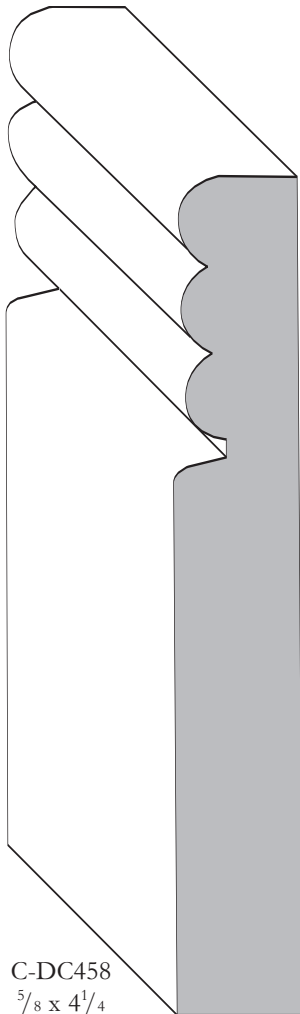

C-DC458
 $\frac{5}{8} \times 4\frac{1}{4}$

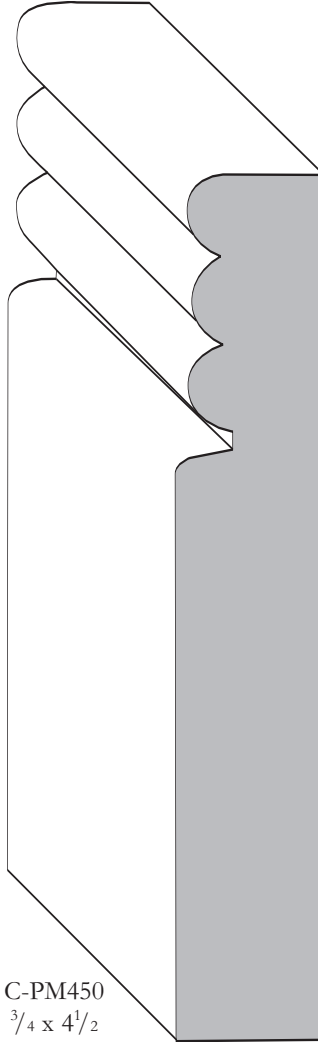

C-PM450
 $\frac{3}{4} \times 4\frac{1}{2}$

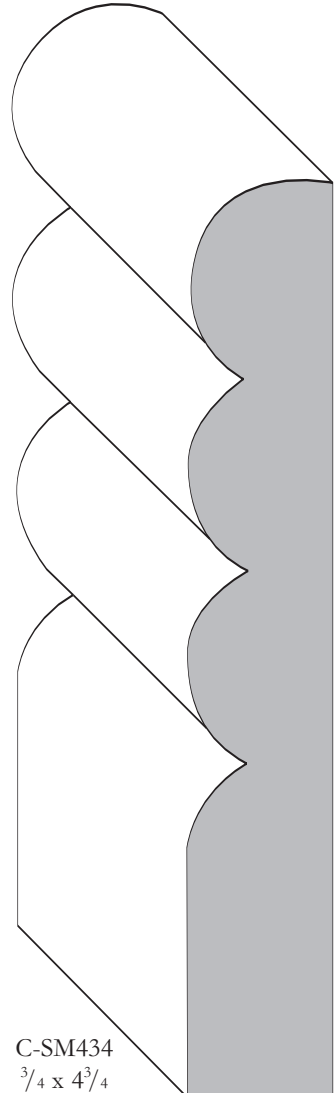

C-SM434
 $\frac{3}{4} \times 4\frac{3}{4}$



BASE

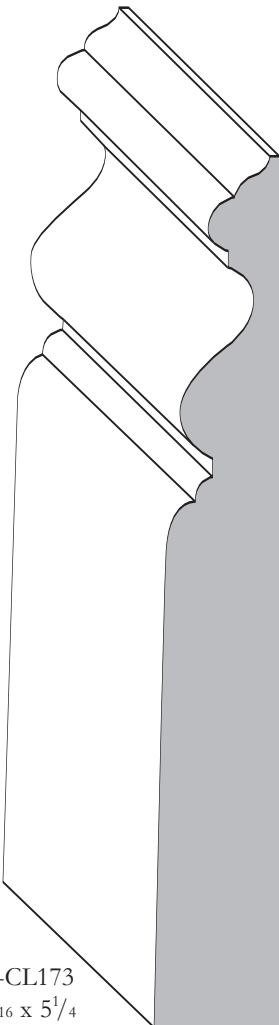
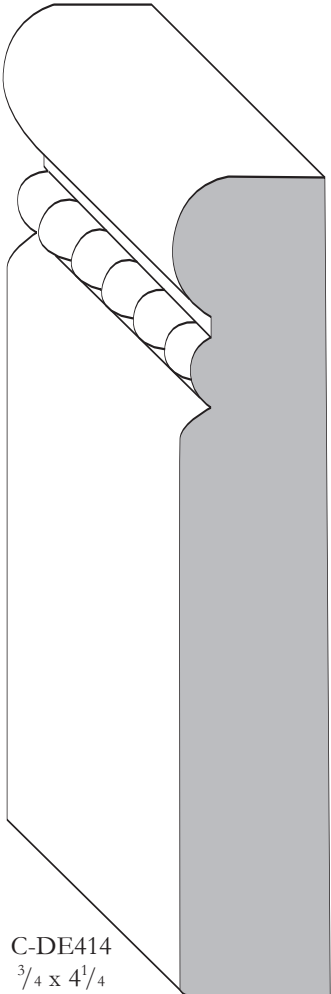
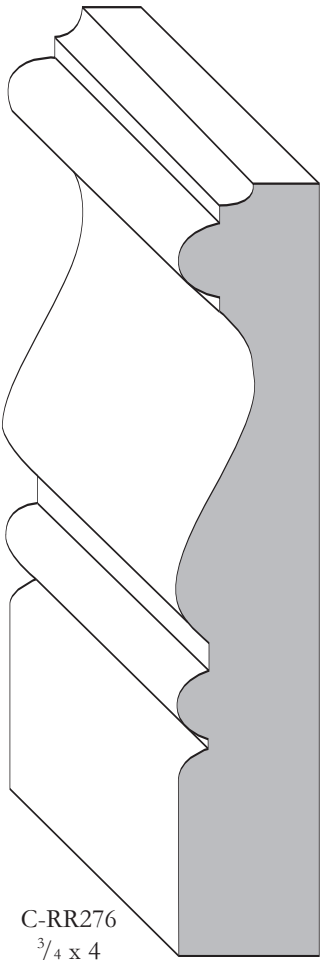
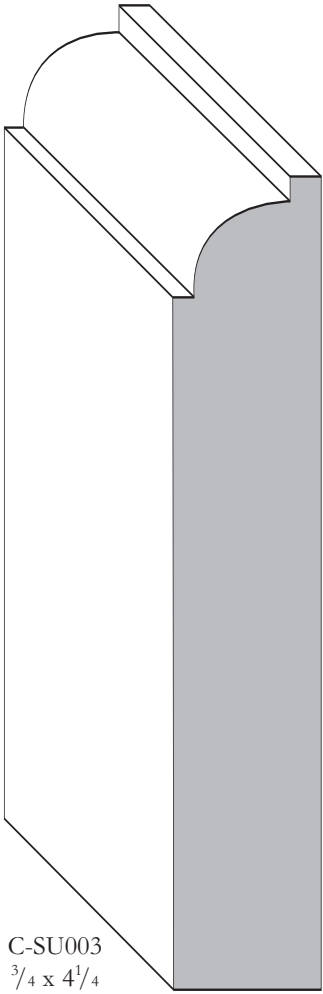

BASE

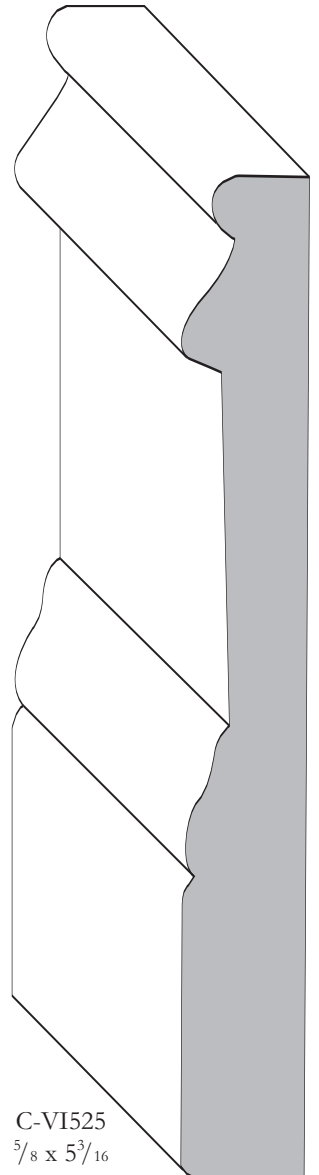
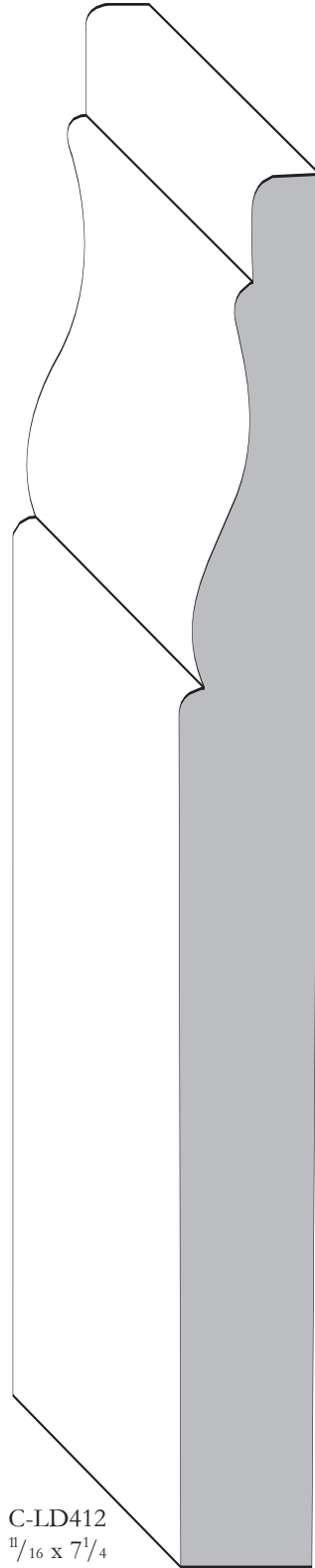
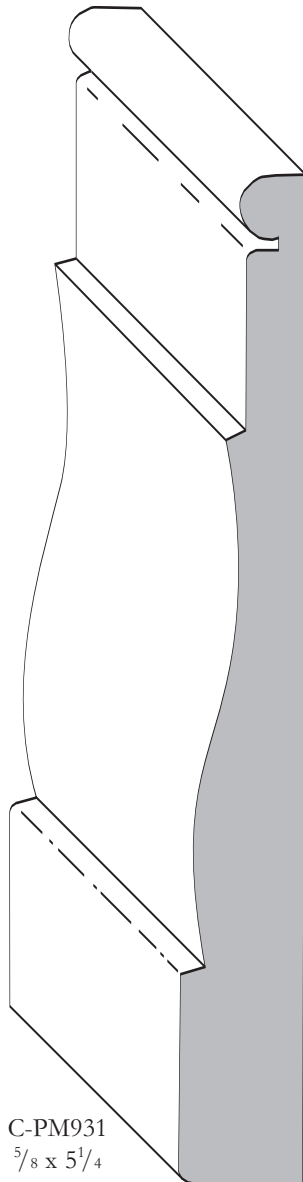
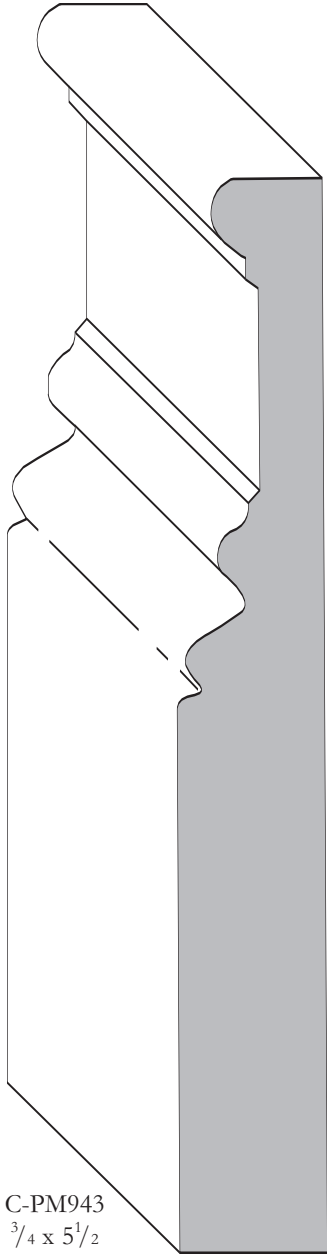

BASE

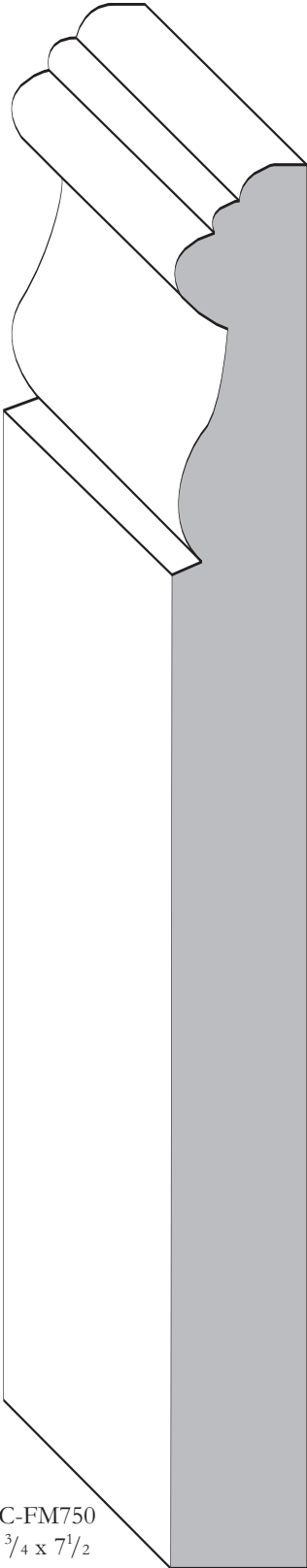
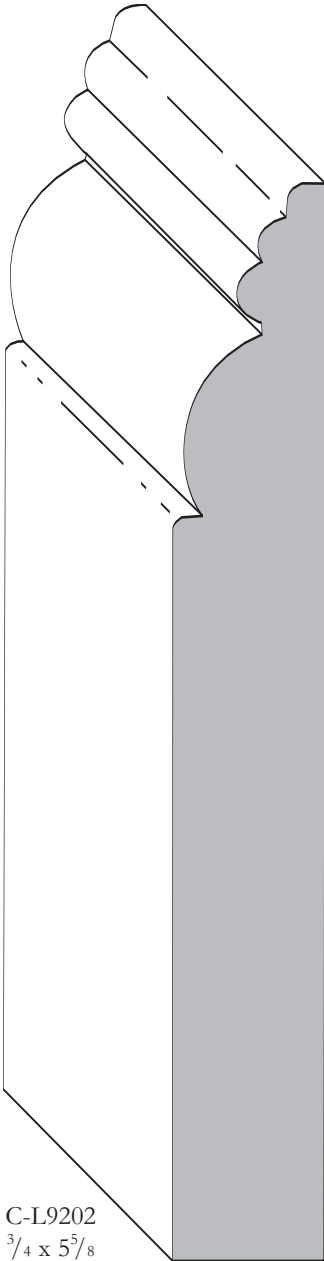
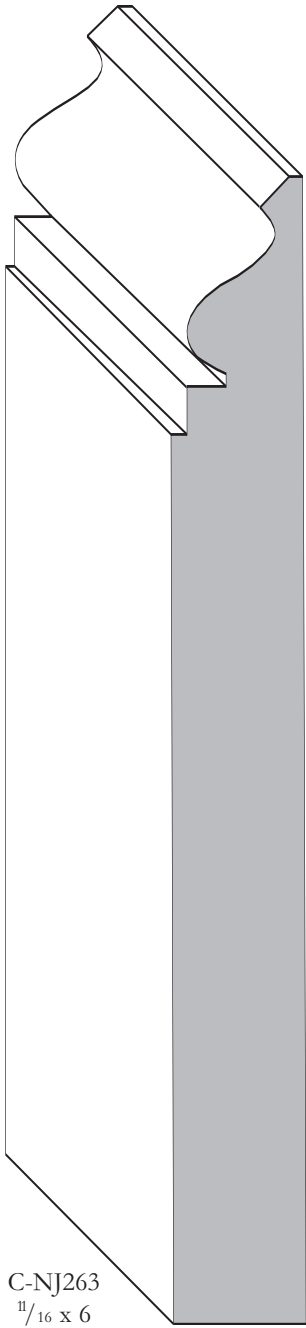
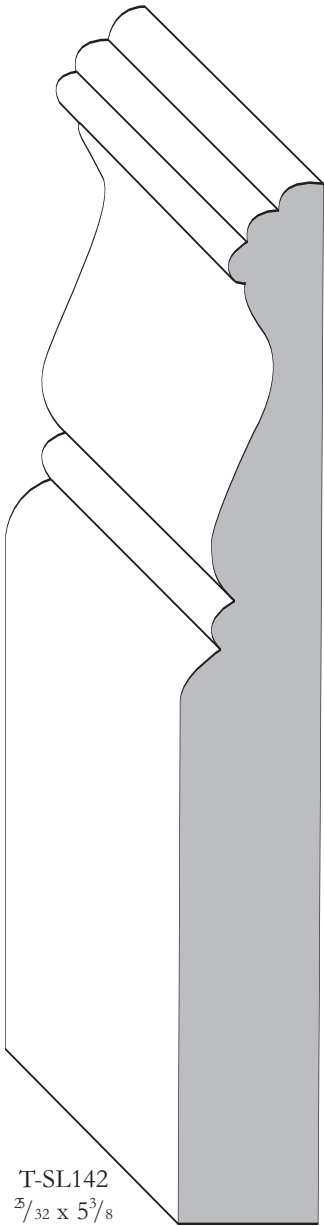

BASE

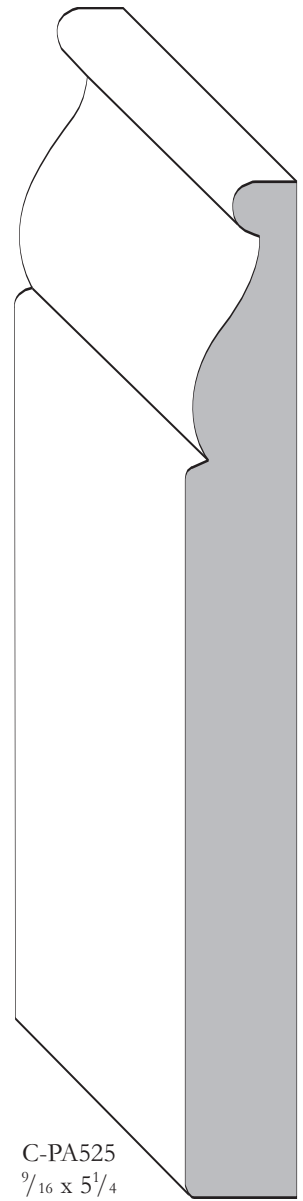
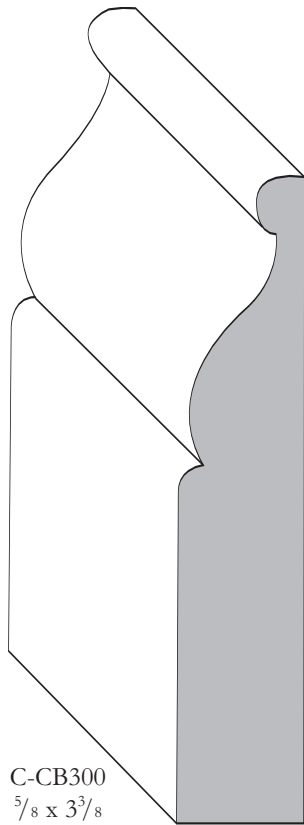
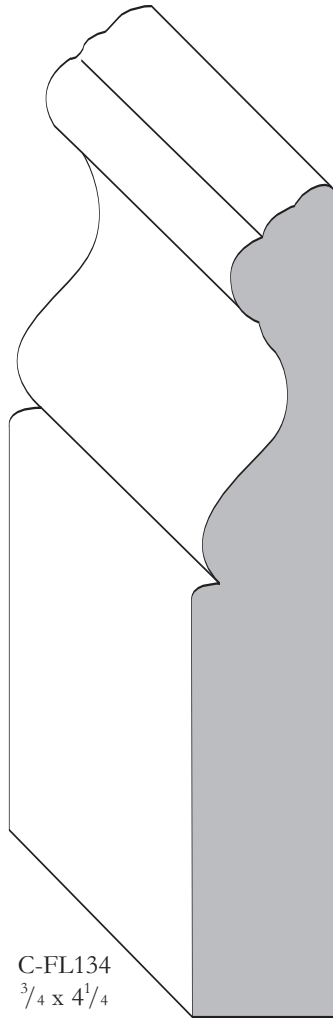
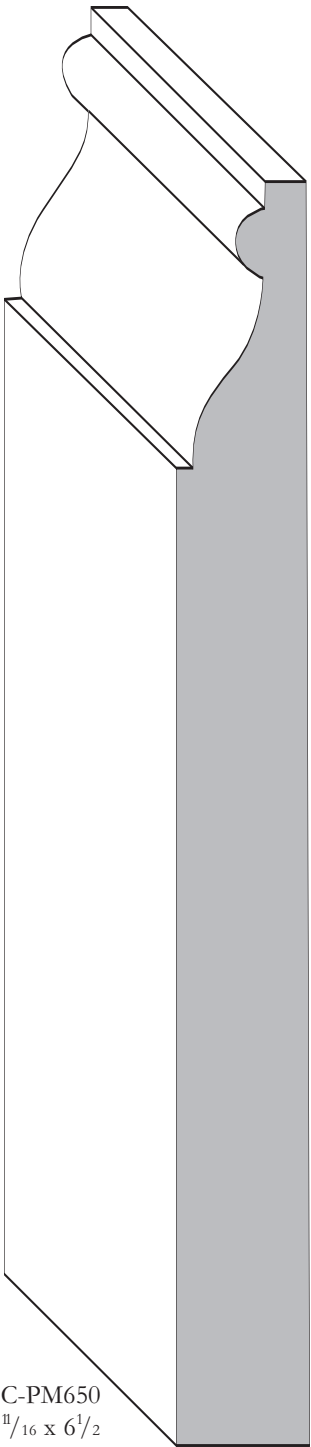

BASE

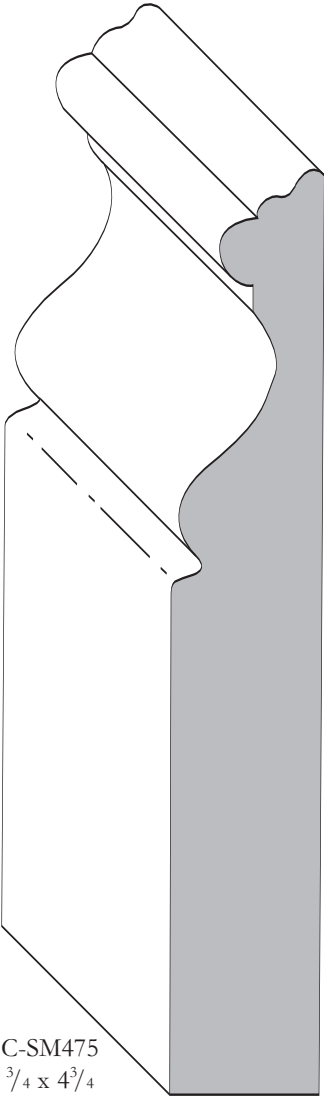

C-SM475
 $\frac{3}{4} \times 4\frac{3}{4}$

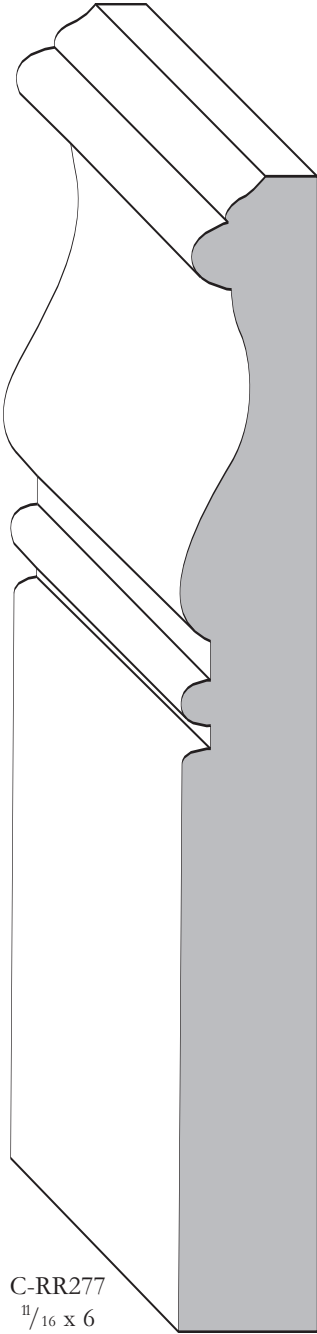

C-RR277
 $\frac{11}{16} \times 6$

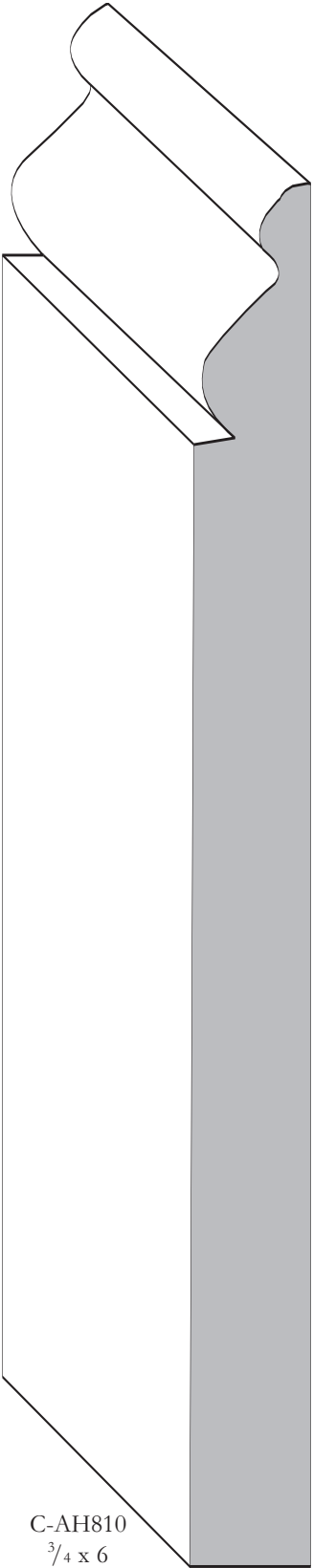

C-AH810
 $\frac{3}{4} \times 6$

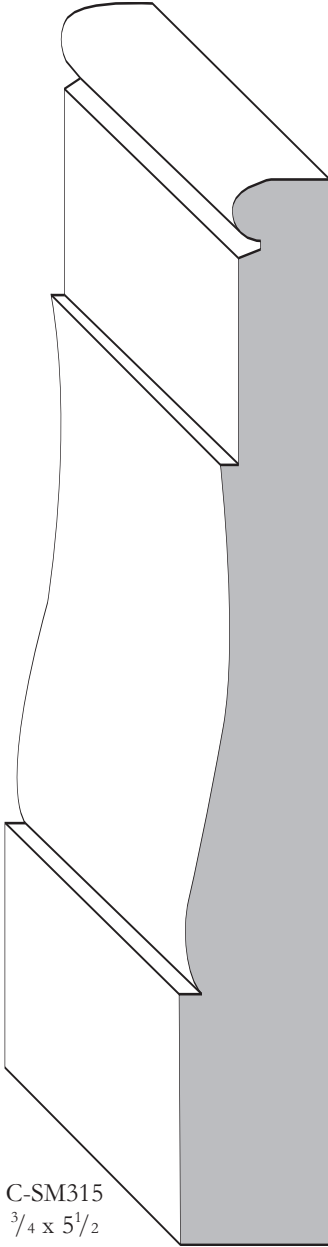

C-SM315
 $\frac{3}{4} \times 5\frac{1}{2}$



BASE

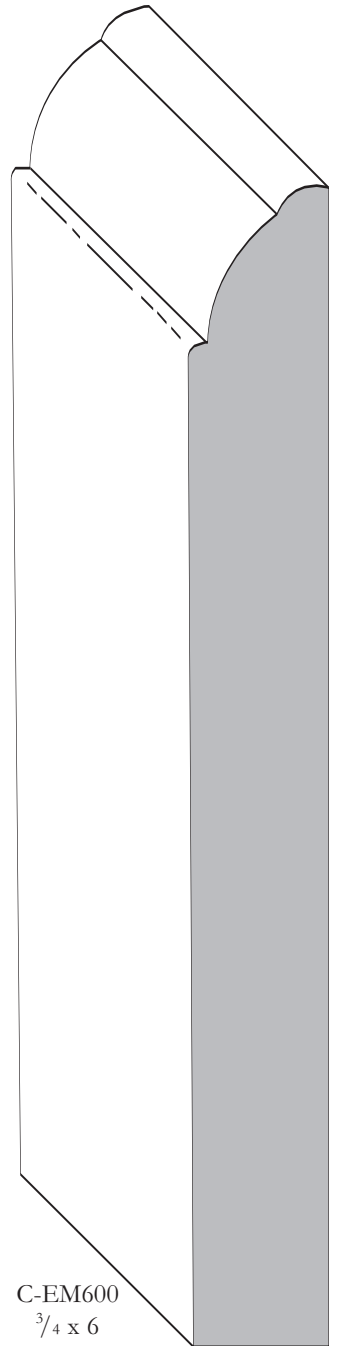
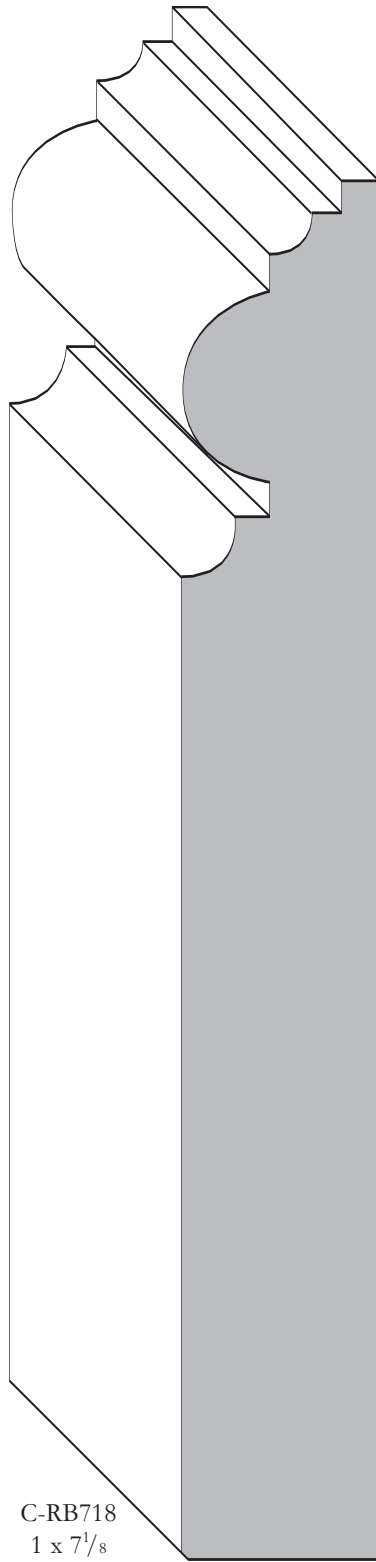
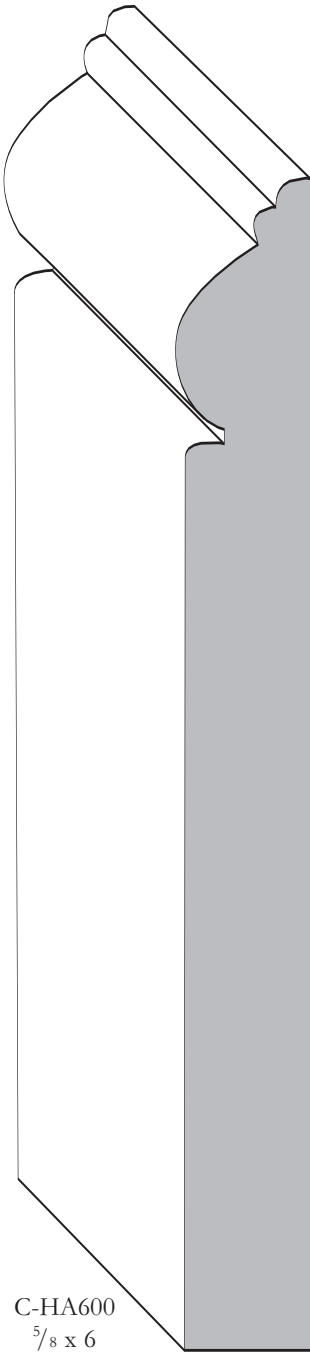
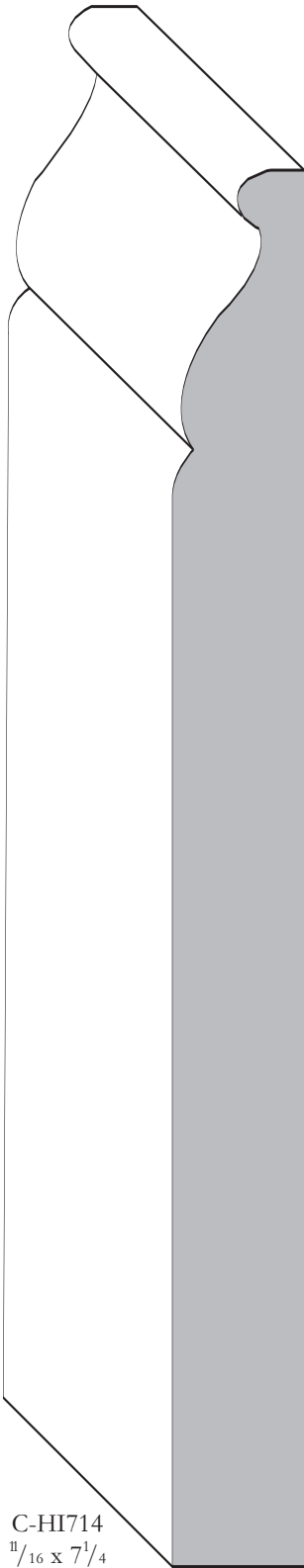

BASE / BASE SHOE

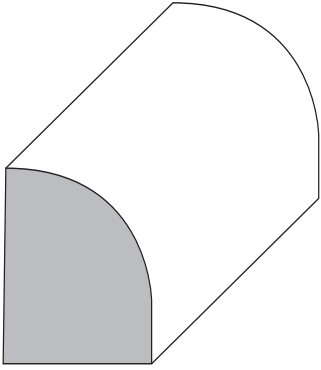

C-SM200
 $\frac{3}{4} \times 1$

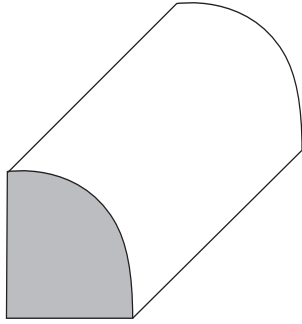

C-NJ722
 $\frac{5}{8} \times \frac{3}{4}$

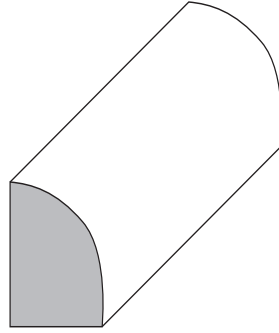

T-WM126
 $\frac{1}{2} \times \frac{3}{4}$

BASE SHOE

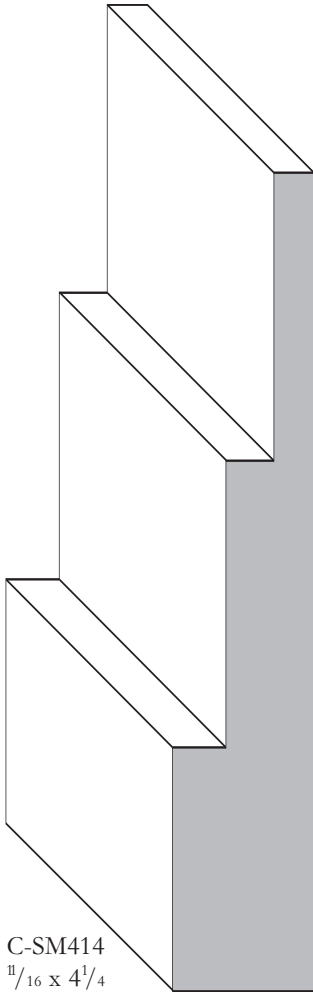

C-SM414
 $\frac{11}{16} \times 4\frac{1}{4}$



BASE CAP

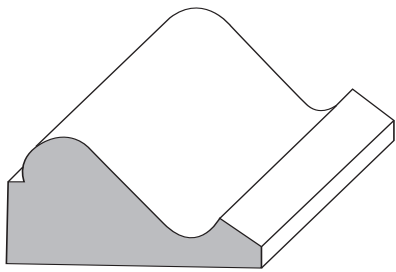

T-WM163
 $\frac{11}{16} \times 1\frac{3}{8}$

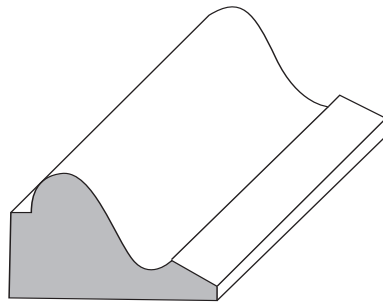

T-WM164
 $\frac{11}{16} \times 1\frac{1}{8}$

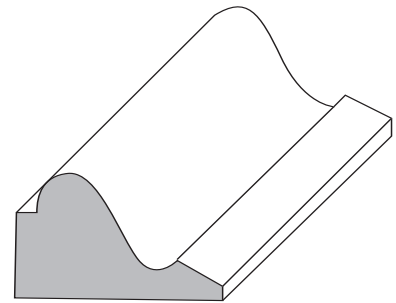

T-WM164
 $\frac{11}{16} \times 1\frac{1}{8}$

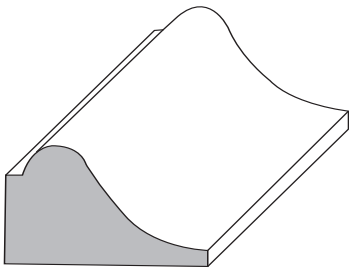

T-WM167
 $\frac{11}{16} \times 1\frac{1}{8}$

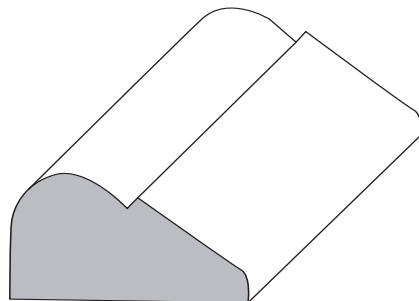

C-BO125
 $\frac{5}{8} \times 1\frac{1}{4}$

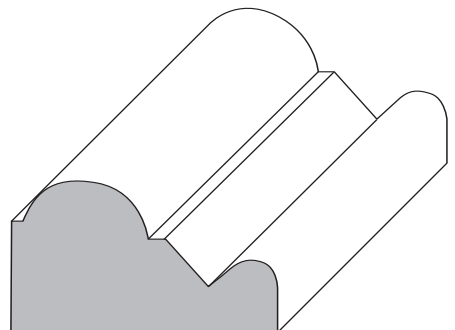

C-SM30
 $\frac{3}{4} \times 1\frac{3}{8}$

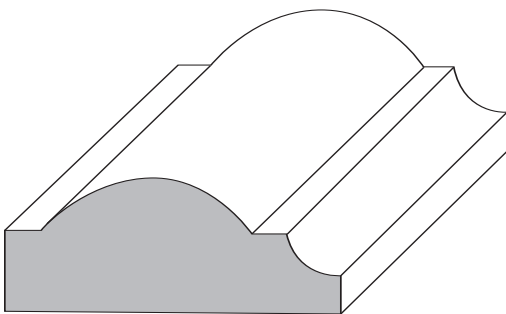

C-R42
 $\frac{11}{16} \times 1\frac{3}{4}$

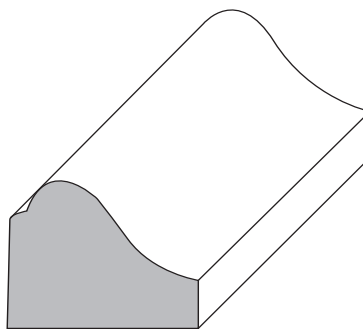

T-SL408
 $\frac{3}{4} \times 1$

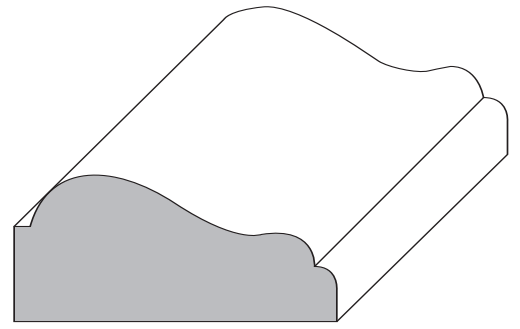

T-SL435
 $\frac{3}{4} \times 1\frac{5}{8}$

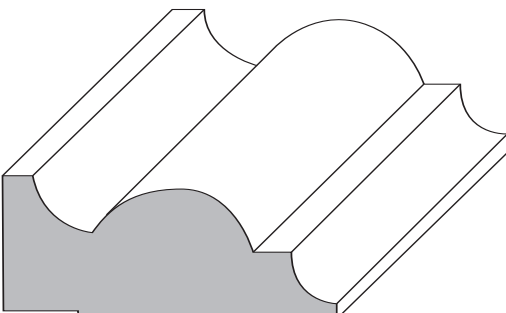

C-DSCAP
 $\frac{3}{4} \times 1\frac{3}{4}$

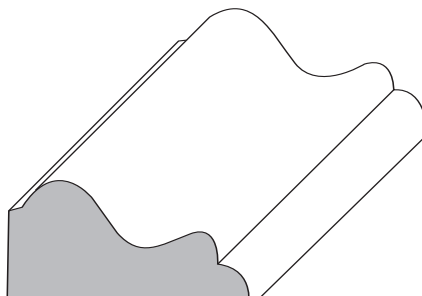

T-SL408
 $\frac{5}{8} \times 1\frac{1}{4}$

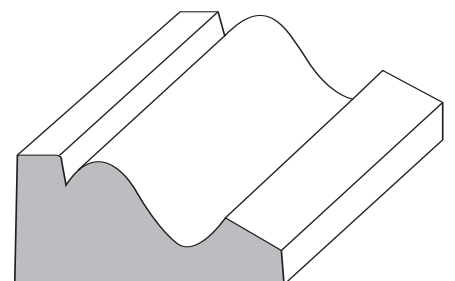

C-GB218
 $\frac{3}{4} \times 1\frac{1}{2}$



CROWN

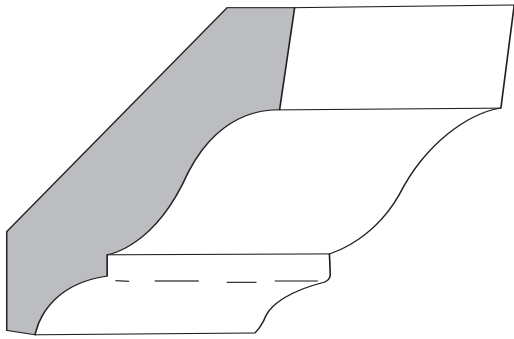

T-WM054
 $\frac{9}{16} \times 2\frac{1}{4}$

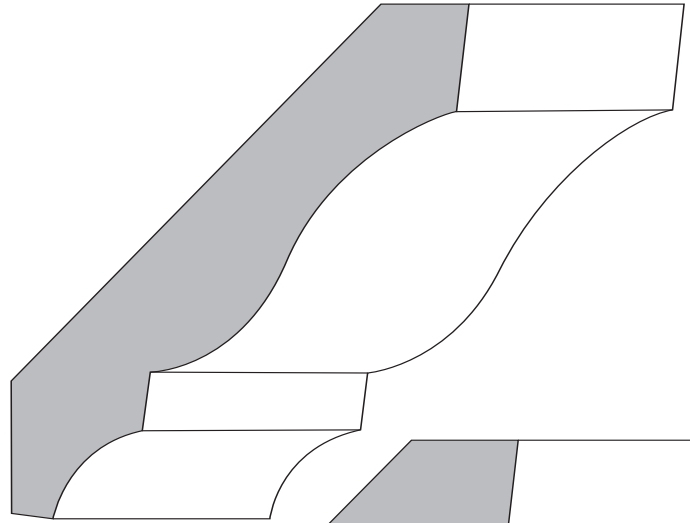

T-WM049
 $\frac{9}{16} \times 3\frac{5}{8}$

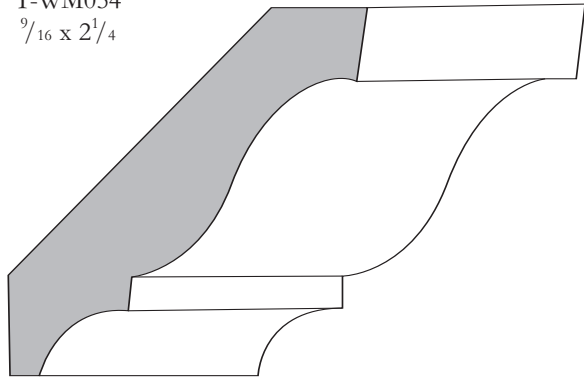

T-WM053
 $\frac{9}{16} \times 2\frac{5}{8}$

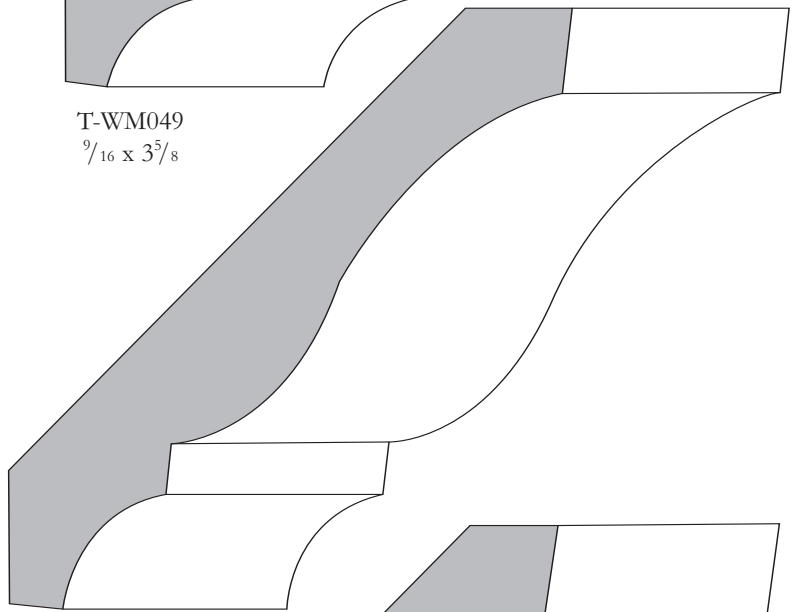

T-WM048
 $\frac{9}{16} \times 4\frac{1}{4}$

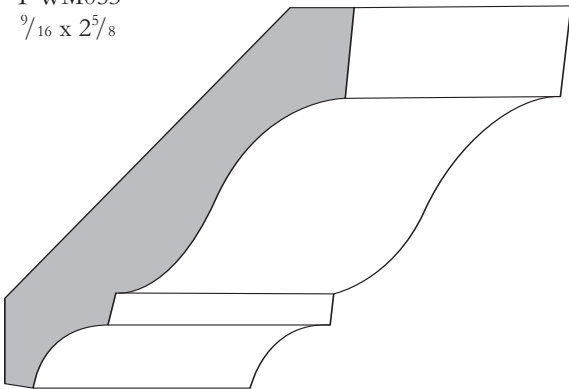

T-WM052
 $\frac{9}{16} \times 2\frac{3}{4}$

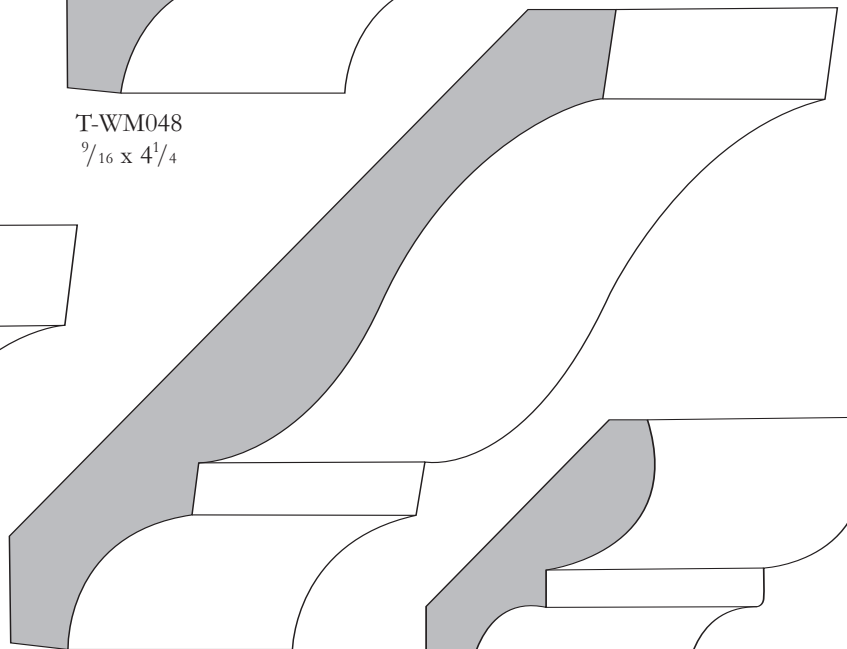

T-WM047
 $\frac{9}{16} \times 4\frac{5}{8}$

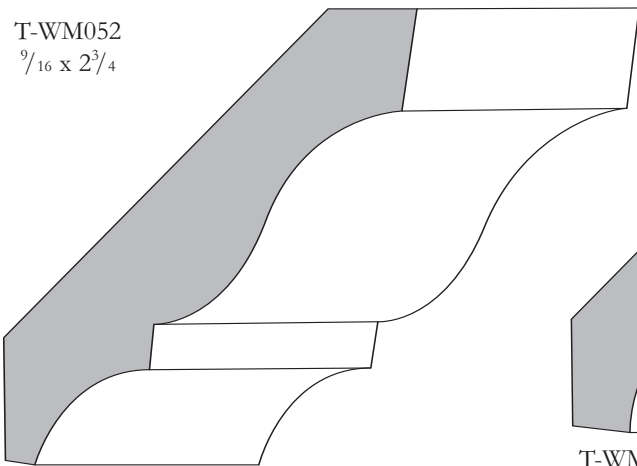

T-WM051
 $\frac{11}{16} \times 3\frac{1}{4}$

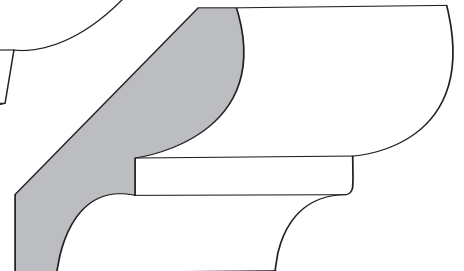

T-WM074
 $\frac{9}{16} \times 1\frac{3}{4}$

CROWN

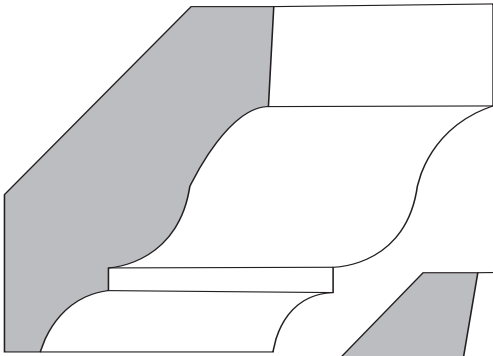

C-PO540
 $\frac{3}{4} \times 2\frac{1}{4}$

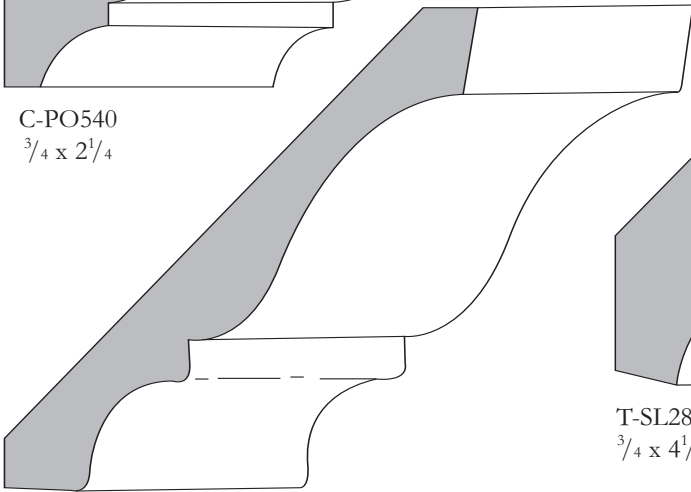

T-SL287
 $\frac{1}{2} \times 3\frac{1}{2}$

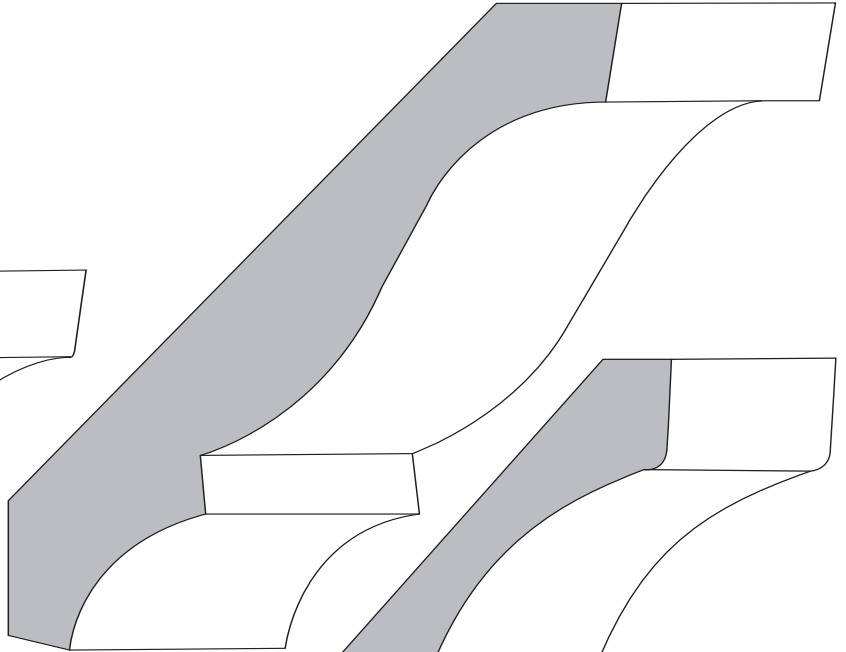

T-SL288
 $\frac{3}{4} \times 4\frac{1}{2}$

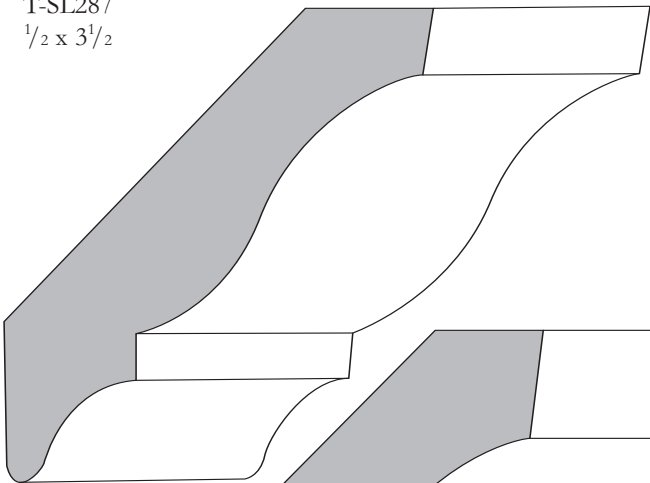

C-NJ319
 $\frac{11}{16} \times 3\frac{1}{4}$

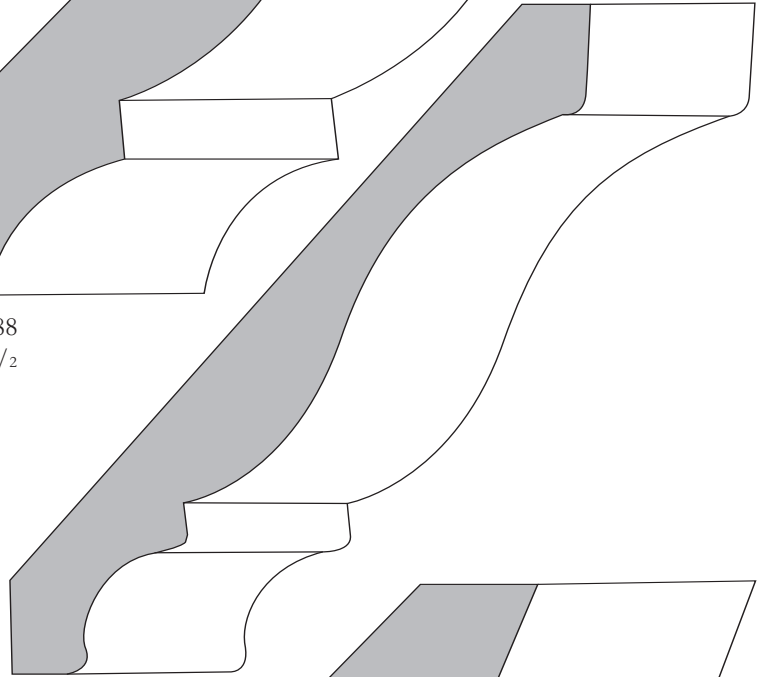

C-RB17
 $\frac{5}{8} \times 5\frac{5}{8}$

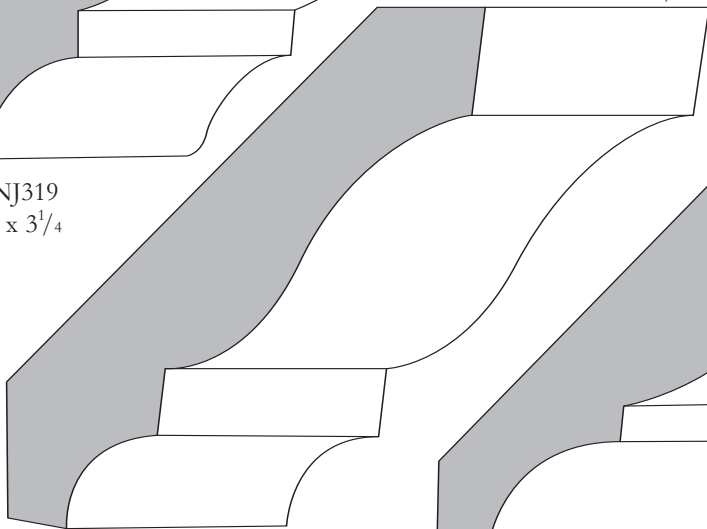

C-PO525
 $\frac{3}{4} \times 3\frac{5}{8}$

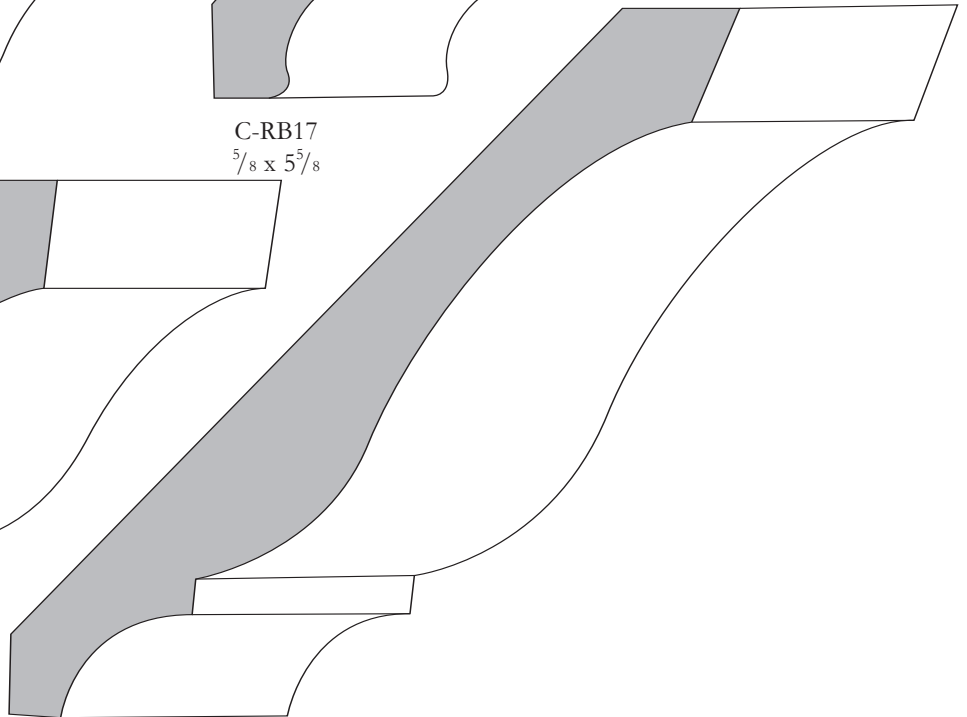

T-WM045
 $\frac{11}{16} \times 5\frac{1}{4}$

CROWN

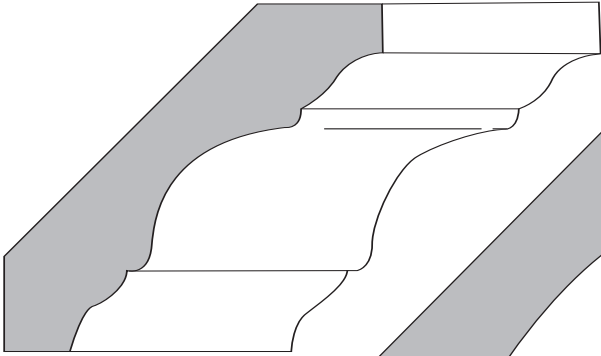

C-OC215
 $\frac{5}{8} \times 2\frac{5}{8}$

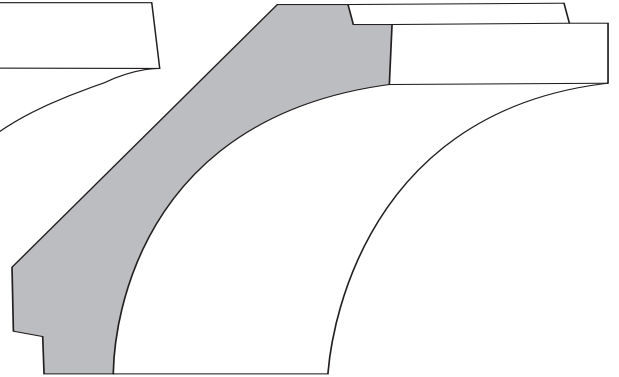

C-OC210
 $\frac{3}{4} \times 2\frac{9}{16}$



C-WW525
 $\frac{3}{4} \times 5\frac{1}{2}$

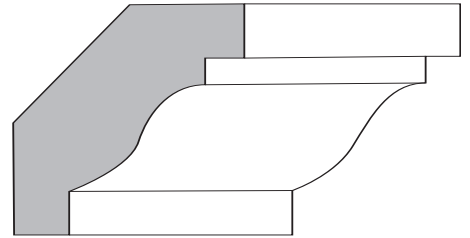

C-OC230
 $\frac{5}{8} \times 1\frac{5}{8}$

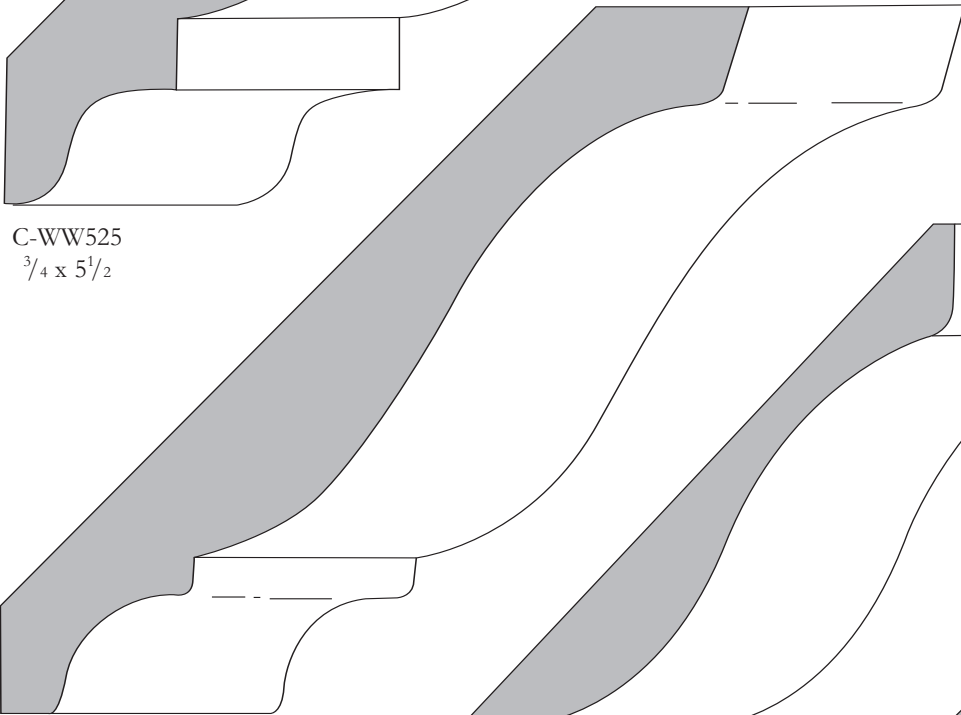

C-CM49
 $\frac{3}{4} \times 5\frac{1}{4}$

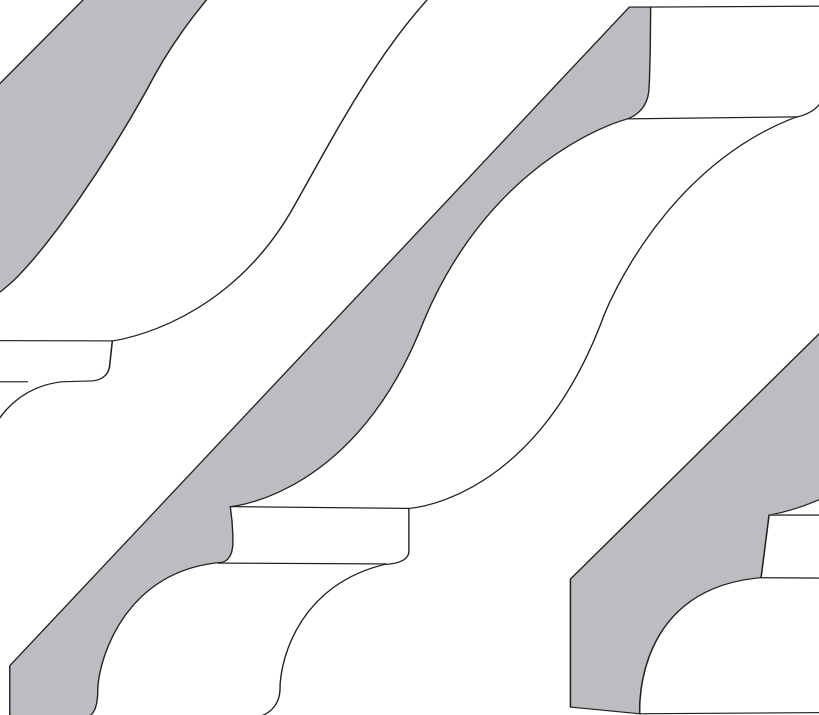

C-EC045
 $\frac{1}{2} \times 5\frac{1}{4}$

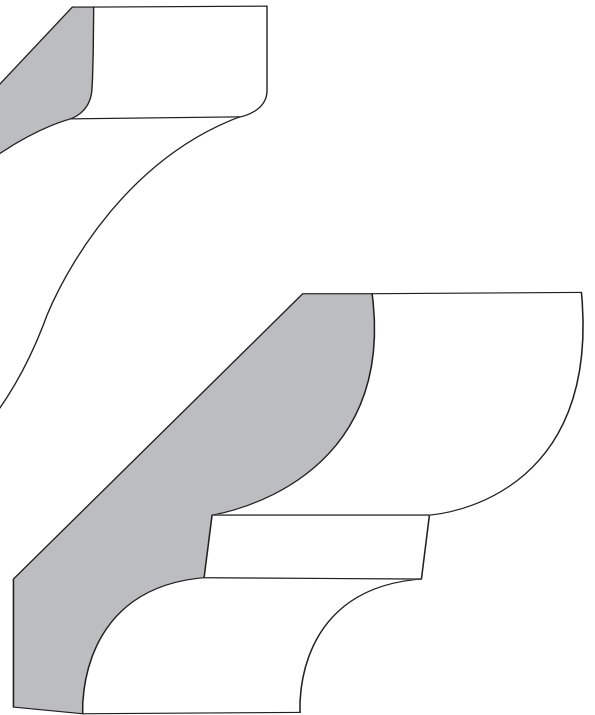

C-OC210
 $\frac{3}{4} \times 2\frac{9}{16}$

CROWN

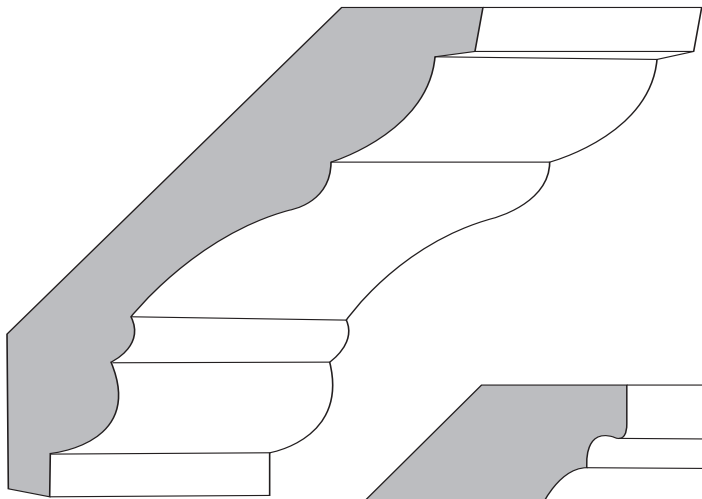

C-NJ311
 $\frac{11}{16} \times 3\frac{1}{2}$

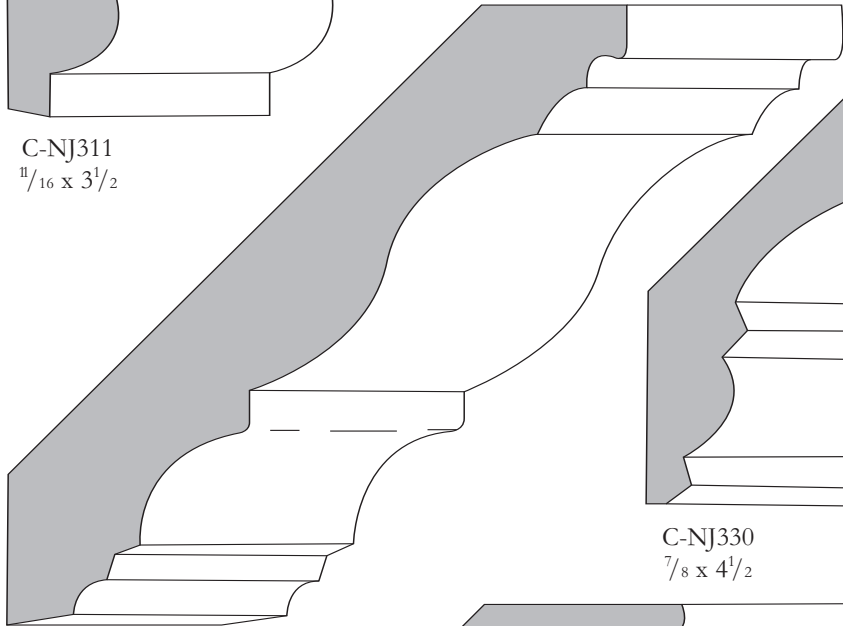

C-NJ330
 $\frac{7}{8} \times 4\frac{1}{2}$

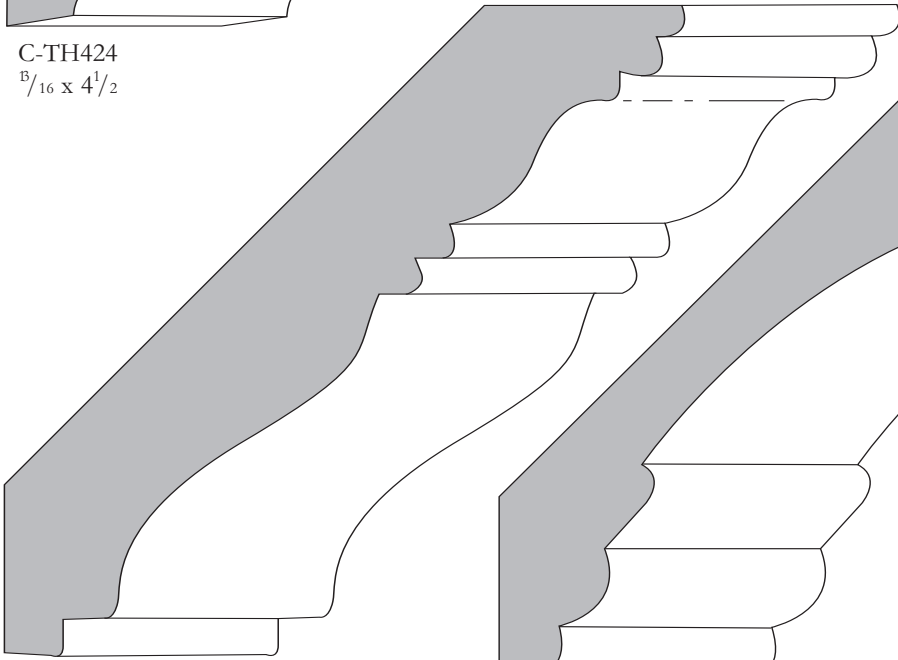

C-TH424
 $\frac{5}{16} \times 4\frac{1}{2}$

C-OC500
 $\frac{7}{8} \times 5$

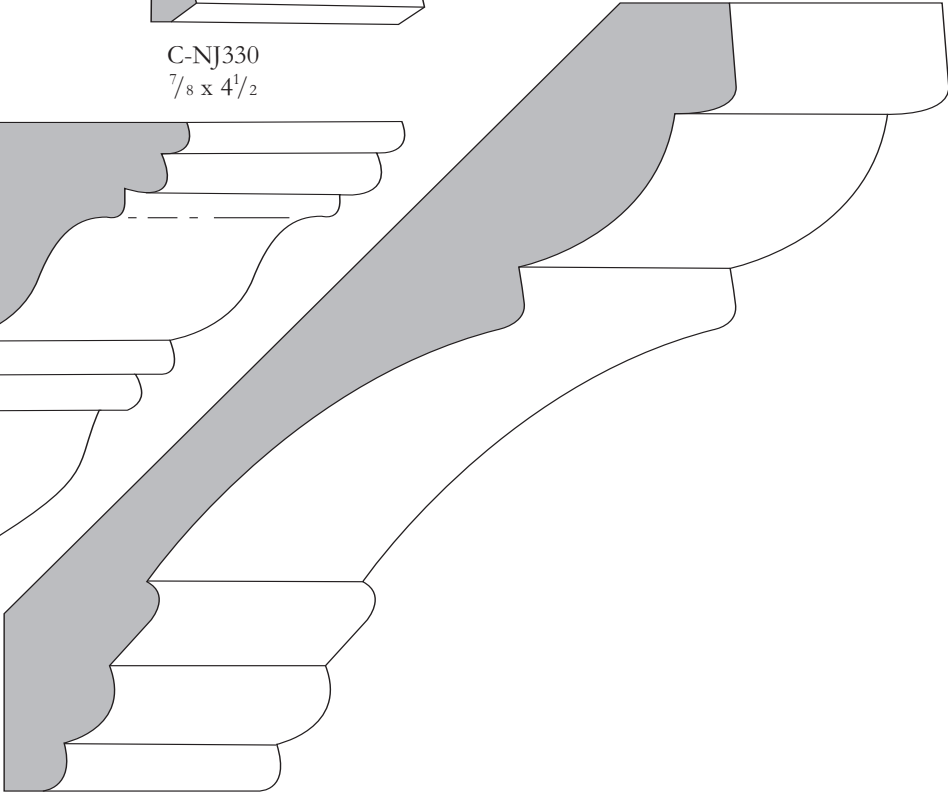

C-DM550
 $\frac{3}{4} \times 5\frac{1}{2}$



CROWN

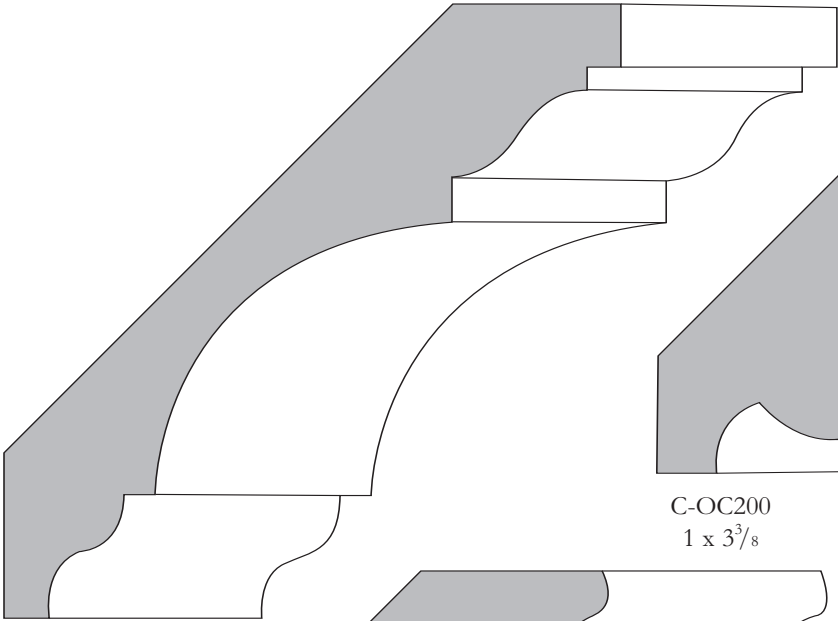

C-OC213
7/8 x 4 1/2

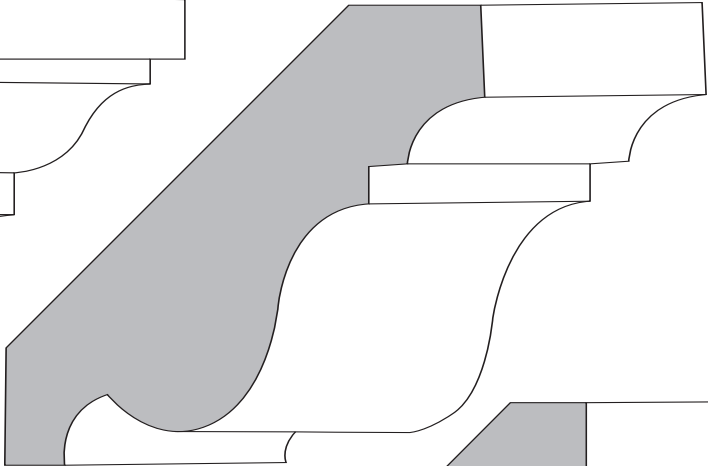

C-OC200
1 x 3 3/8

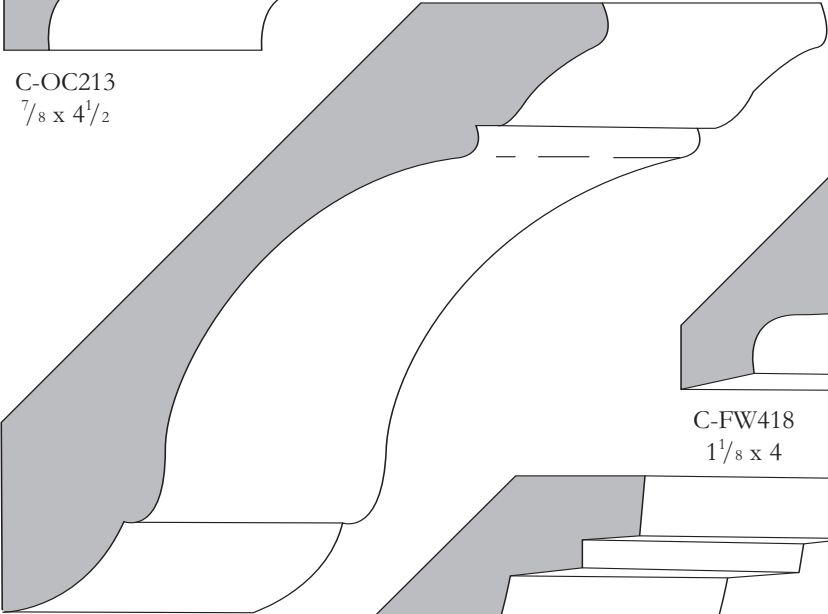

C-DB491
7/8 x 4 3/8

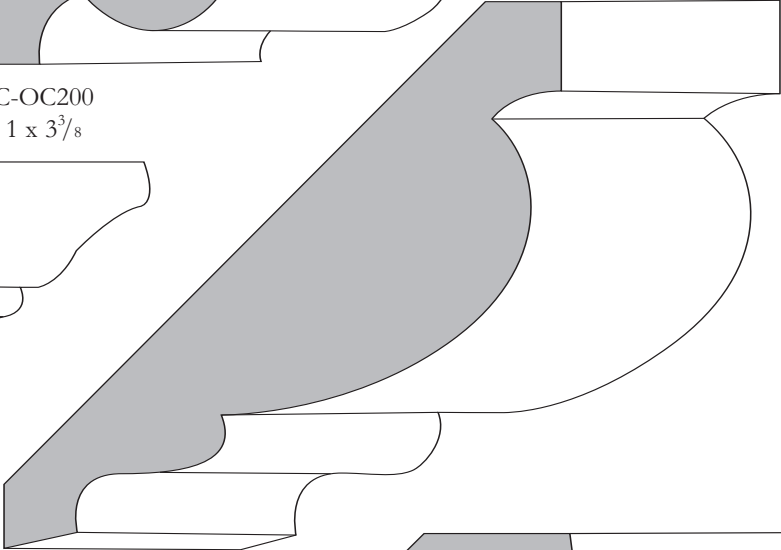

C-FW418
1 1/8 x 4

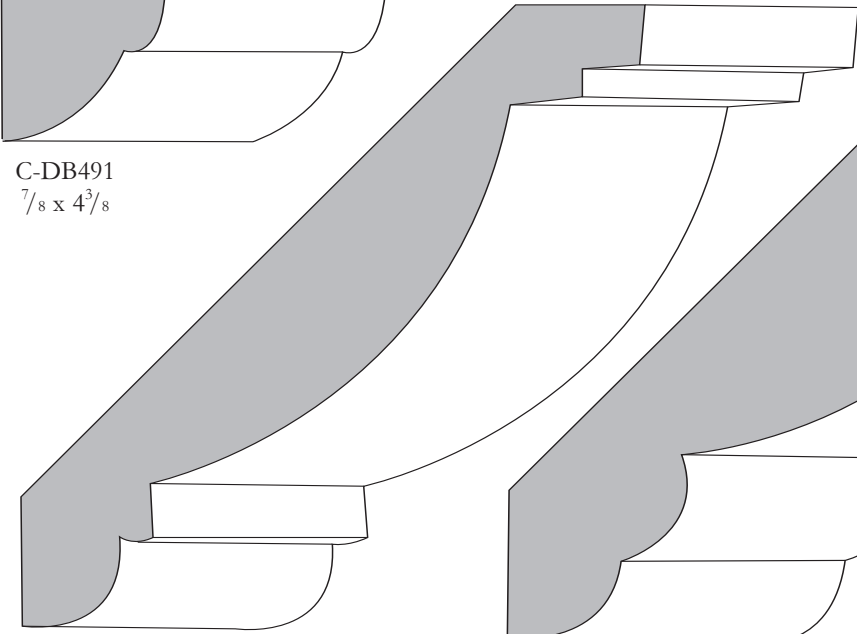

C-PO533
3/4 x 4 1/2

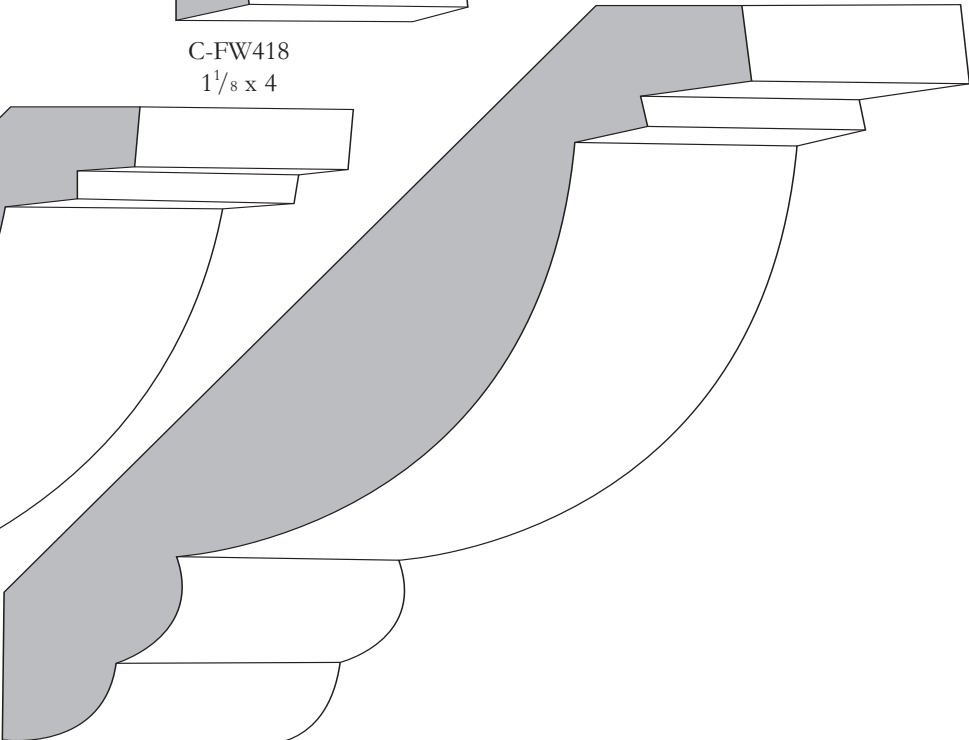

C-PO534
1 x 5 1/4



CROWN

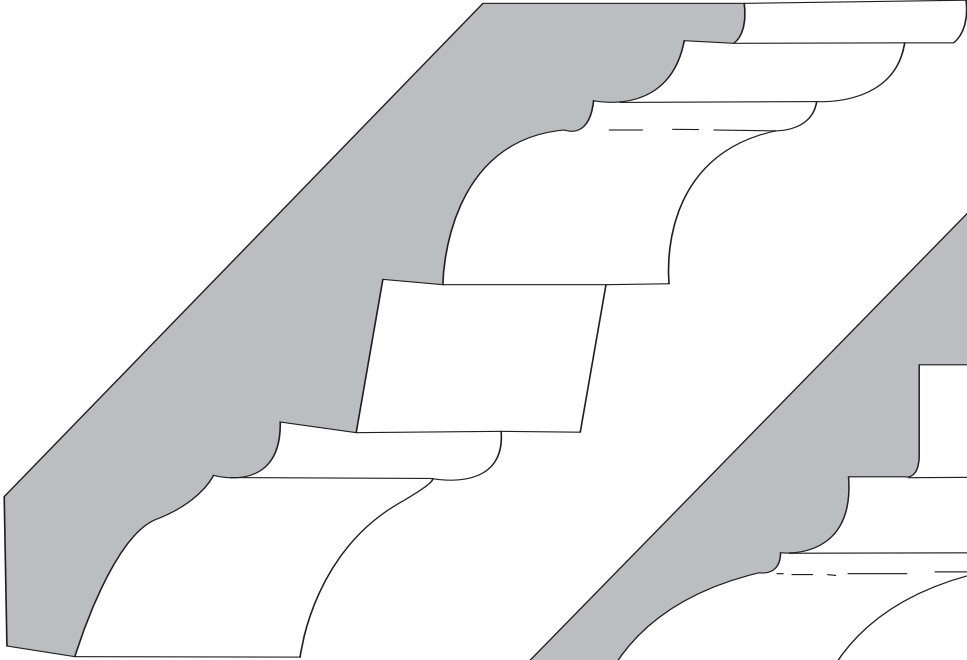

C-SM29
1 x 5

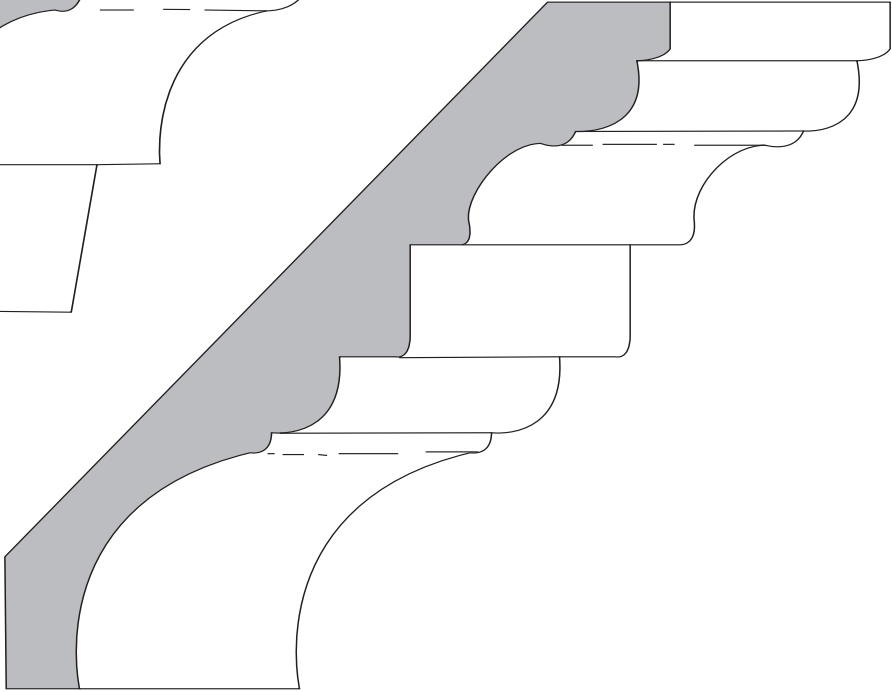

C-DECON
 $\frac{3}{4}$ x 5

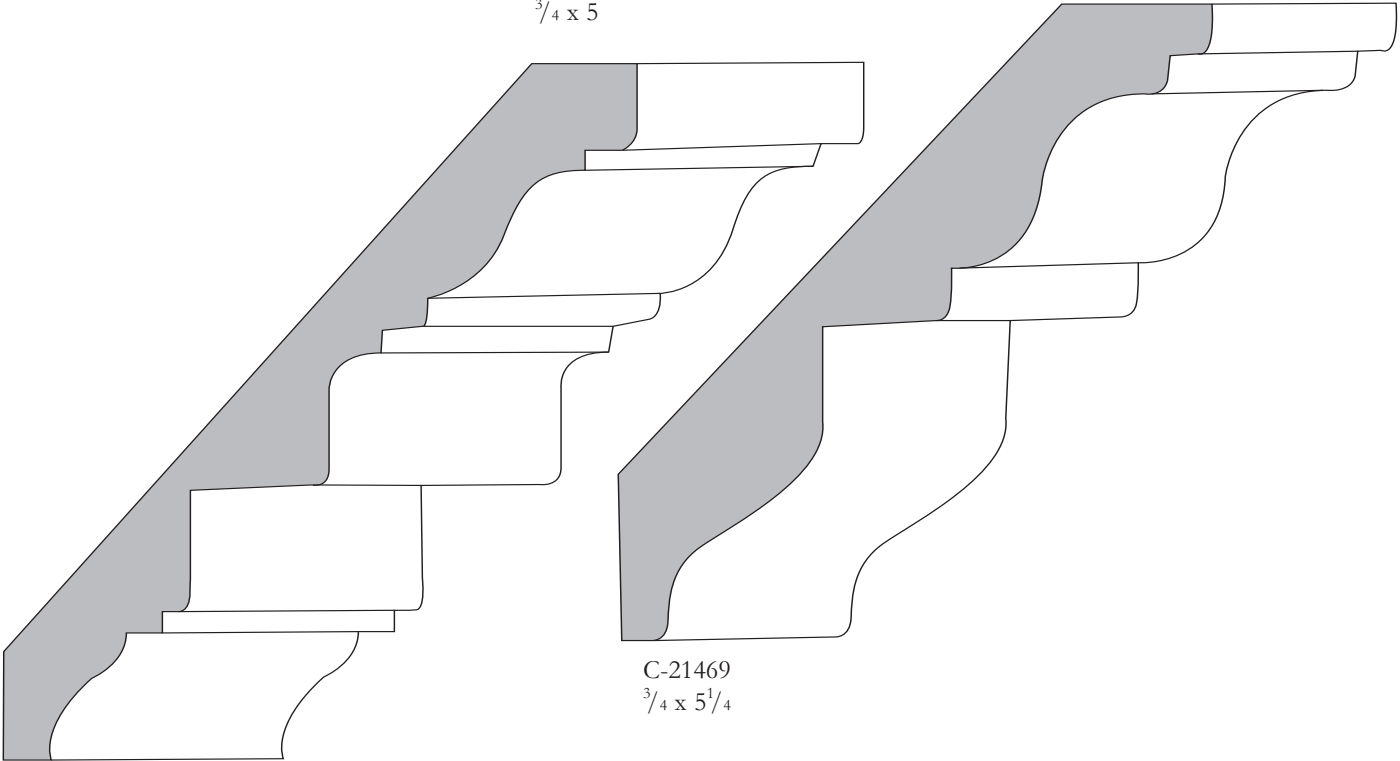

C-SM32
 $\frac{11}{16}$ x $5\frac{1}{4}$

C-21469
 $\frac{3}{4}$ x $5\frac{1}{4}$



CROWN

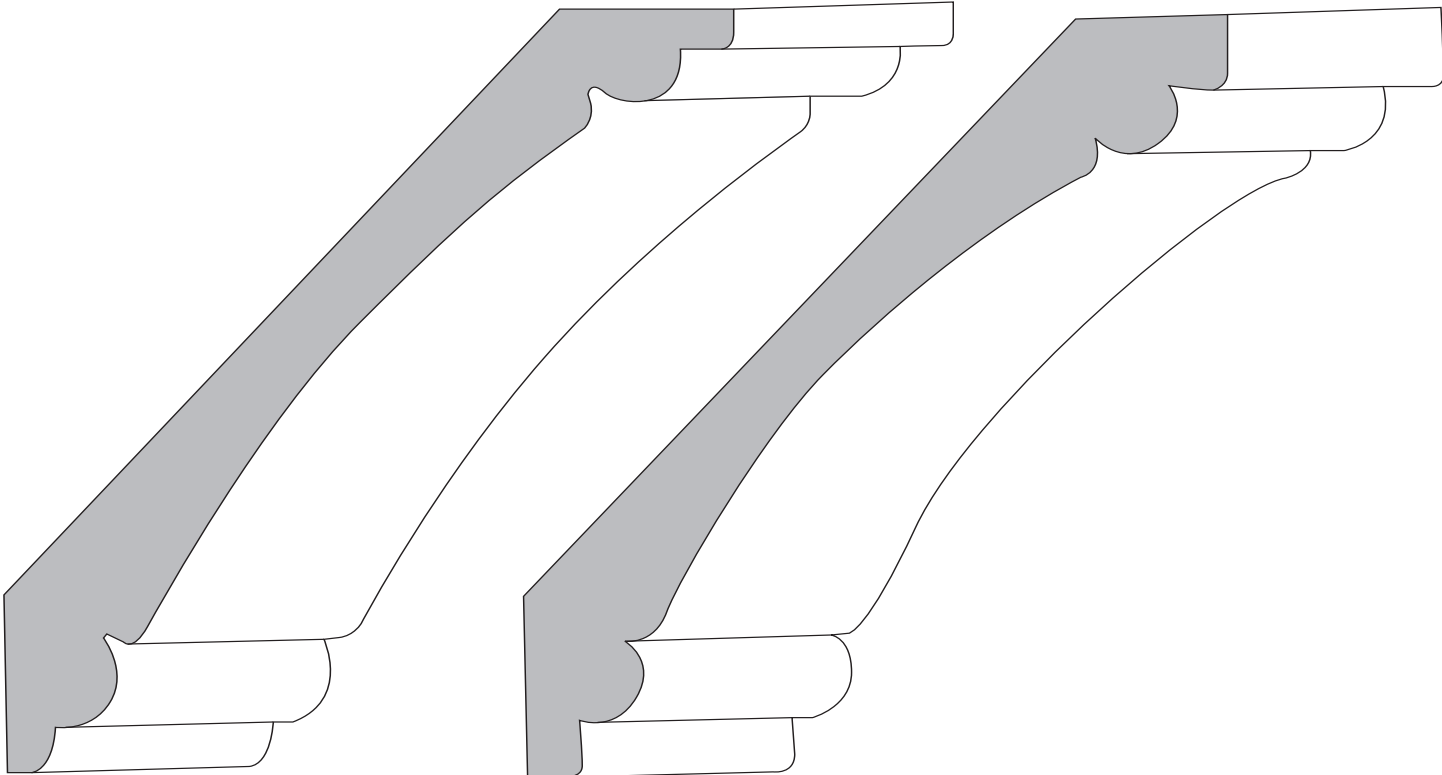

C-BO538
 $\frac{3}{4} \times 5\frac{3}{8}$

C-CM449
 $\frac{15}{16} \times 5\frac{1}{4}$

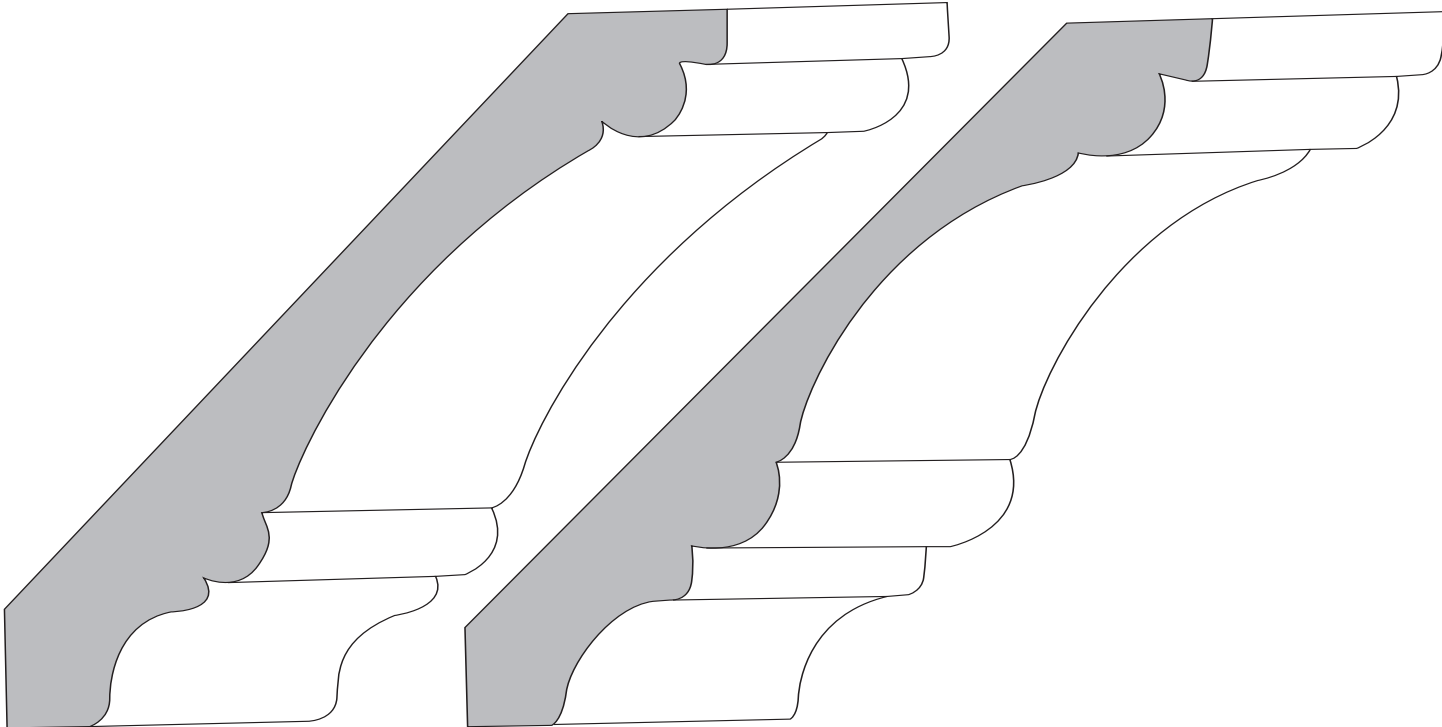

C-CM525
 $\frac{3}{4} \times 5\frac{1}{4}$

C-KB334
 $\frac{3}{4} \times 5\frac{1}{8}$

CROWN

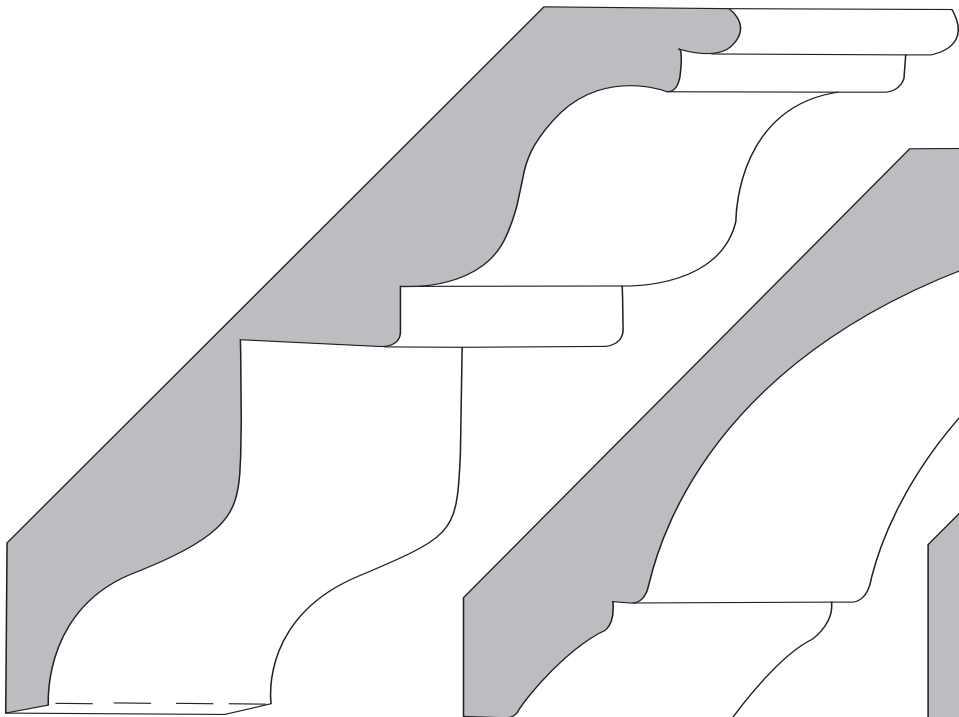

C-PA526
 $\frac{3}{4} \times 5\frac{1}{4}$

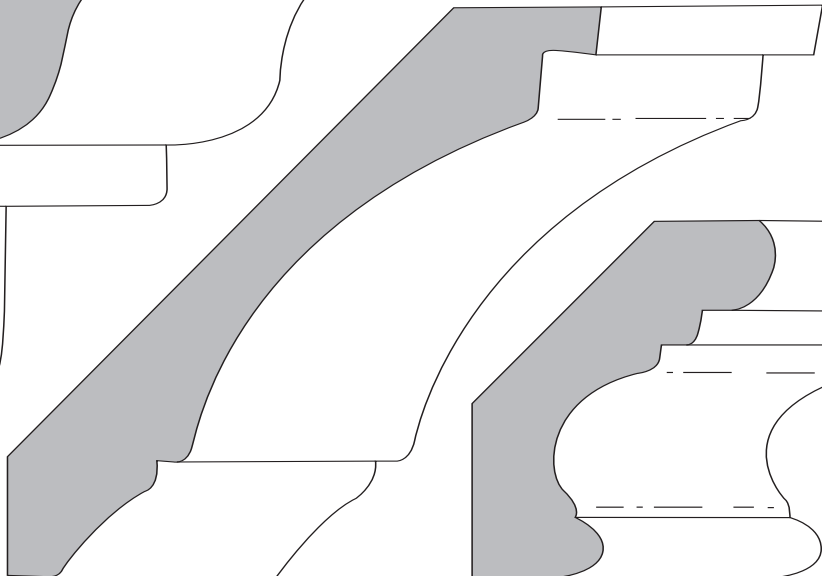

C-CT425
 $\frac{5}{8} \times 4\frac{1}{4}$

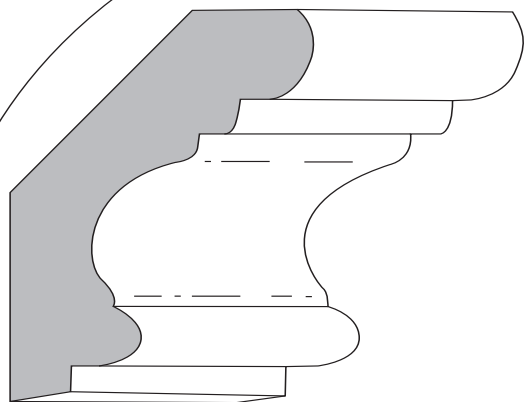

C-OC322
 $1 \times 2\frac{7}{16}$

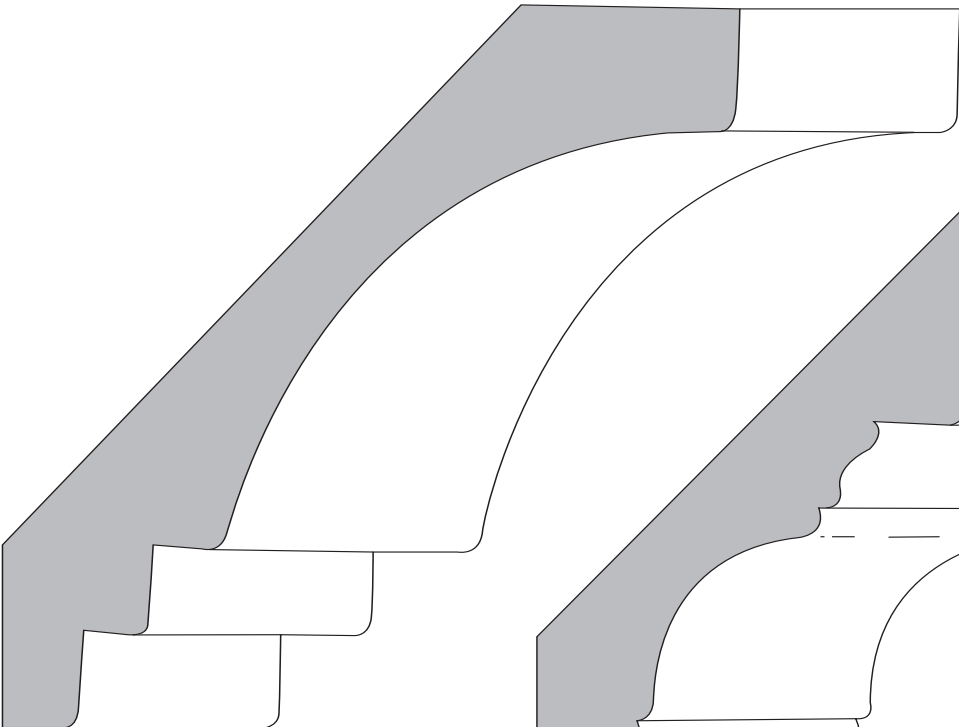

C-MI558
 $1\frac{1}{8} \times 5\frac{5}{8}$

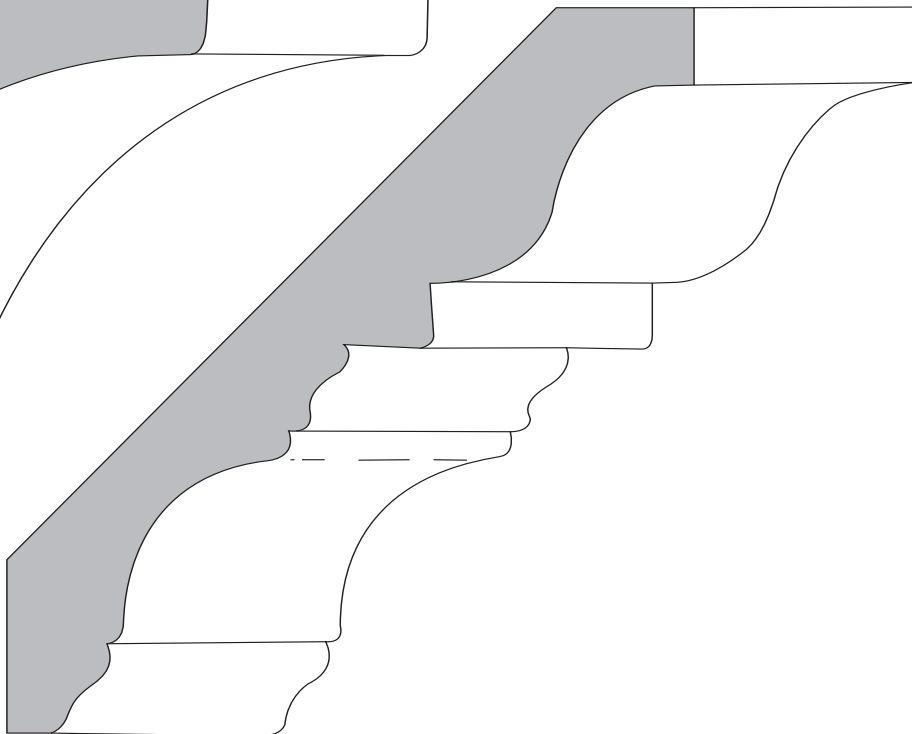

C-PM628
 $\frac{3}{4} \times 5\frac{1}{8}$



CROWN

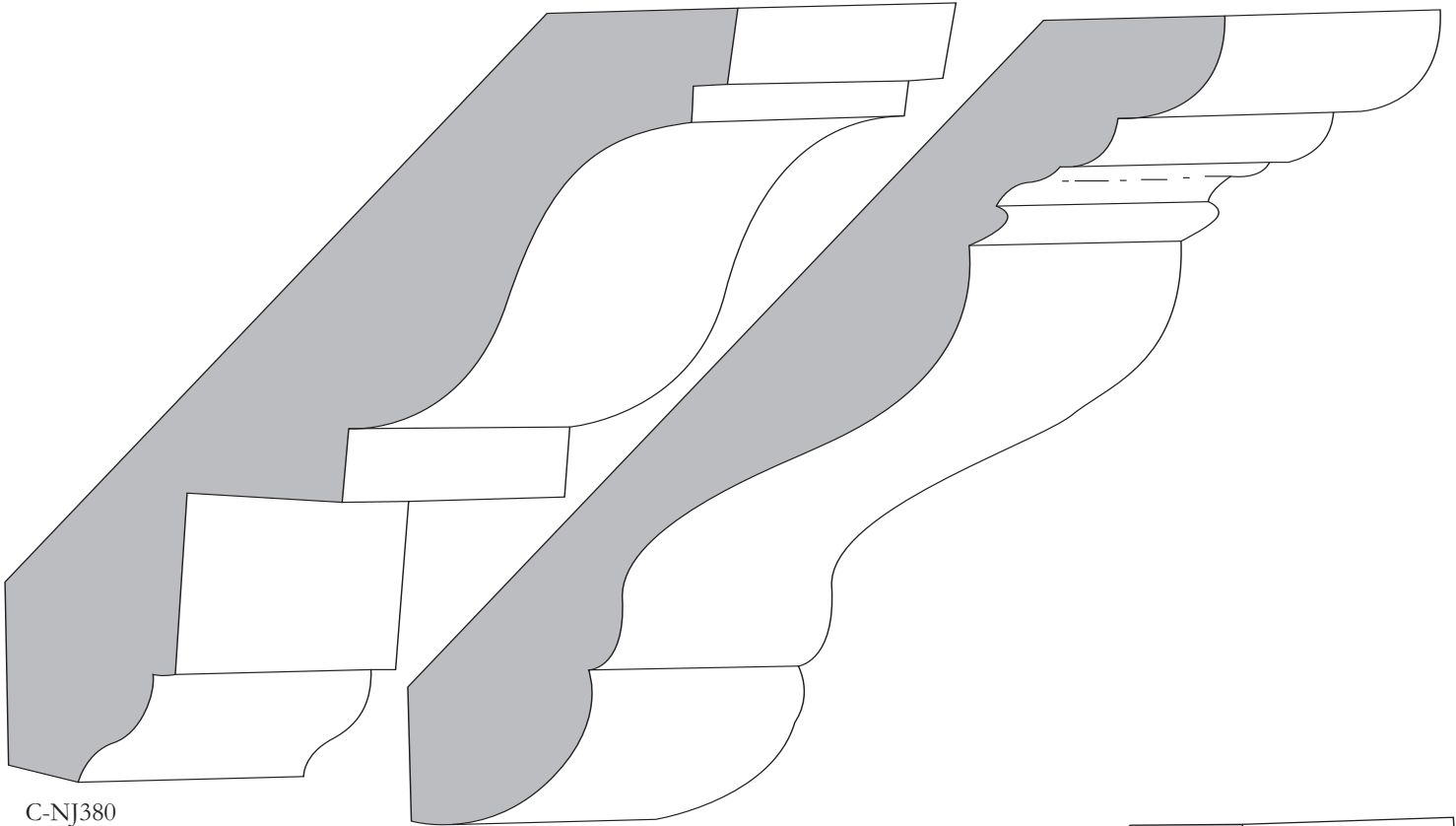

C-NJ380
1 x 5 1/2

T-SL260
5/16 x 6

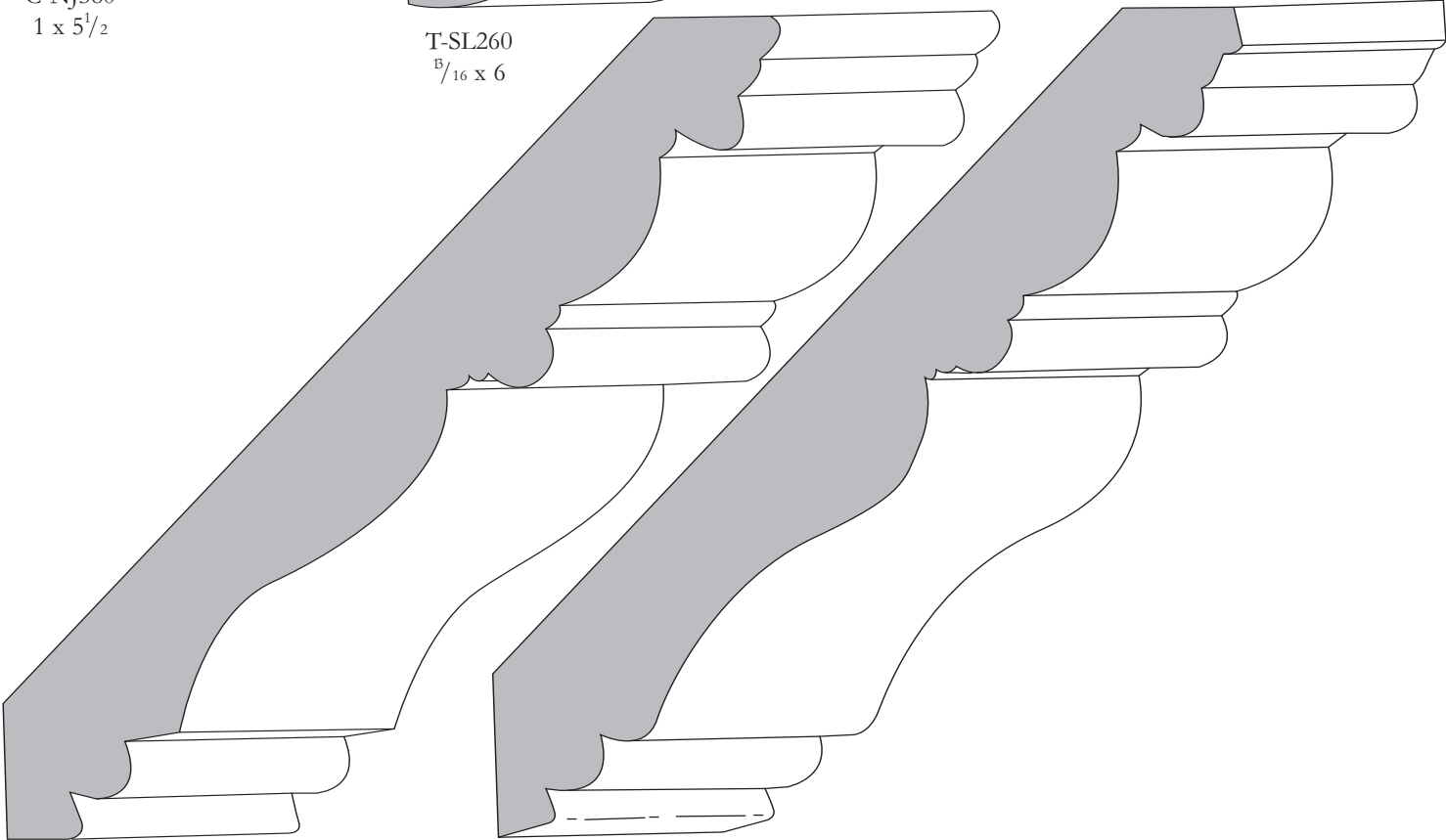

C-FRIED
7/8 x 5 7/8

C-EM227
5/16 x 5 7/8



CROWN

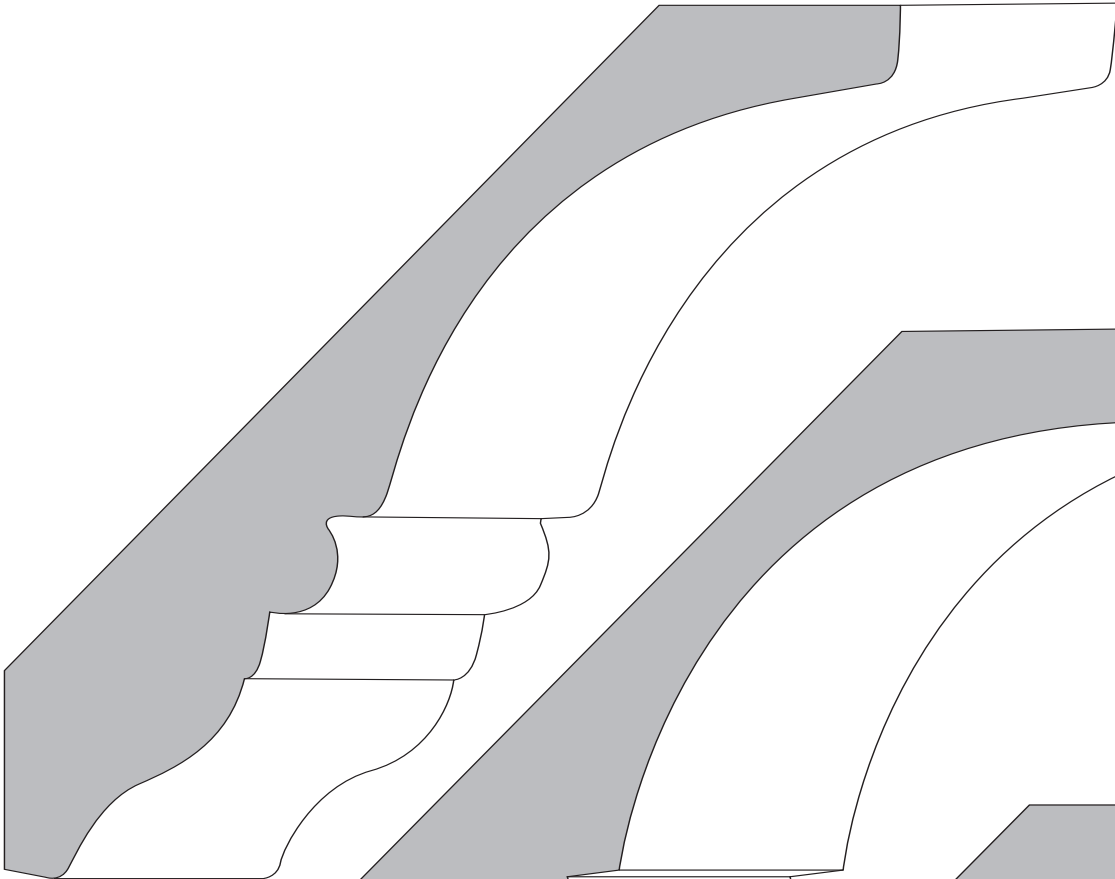

C-LD226
1 x 6³/₈



C-P4440
1¹/₁₆ x 6¹/₂

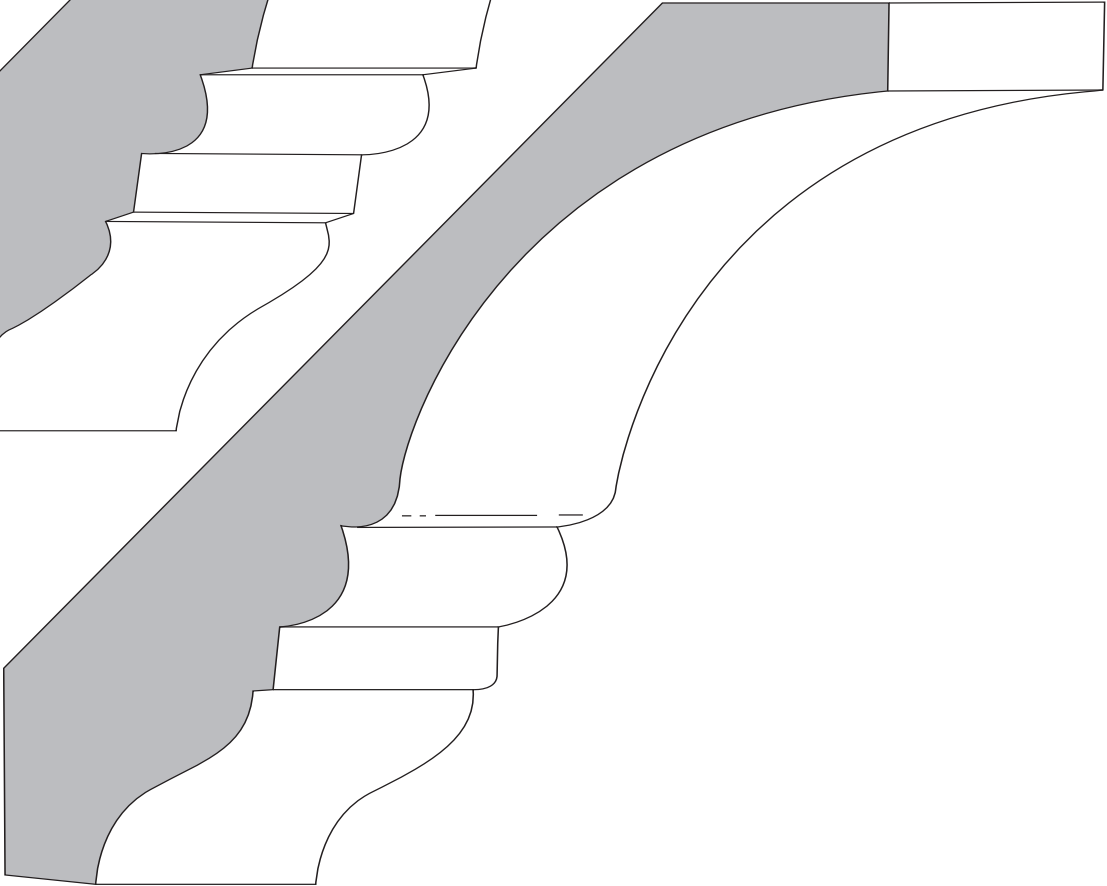

C-C21
1¹/₈ x 6¹/₂



CROWN

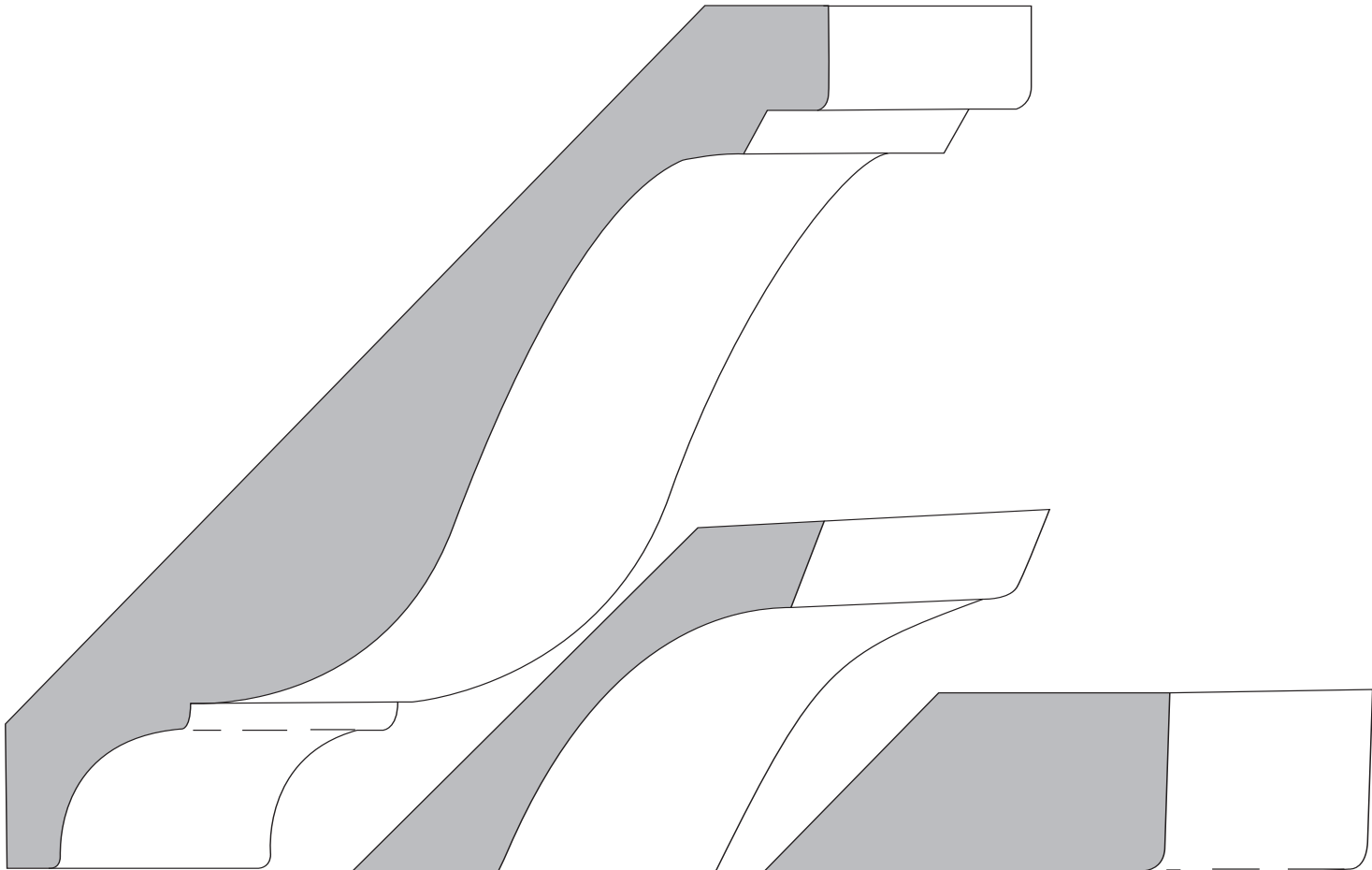

C-BM1
 $1\frac{1}{8} \times 6\frac{5}{8}$

C-CM70
 $\frac{5}{16} \times 7\frac{1}{16}$

C-SM700
 $1\frac{1}{2} \times 7$



CROWN

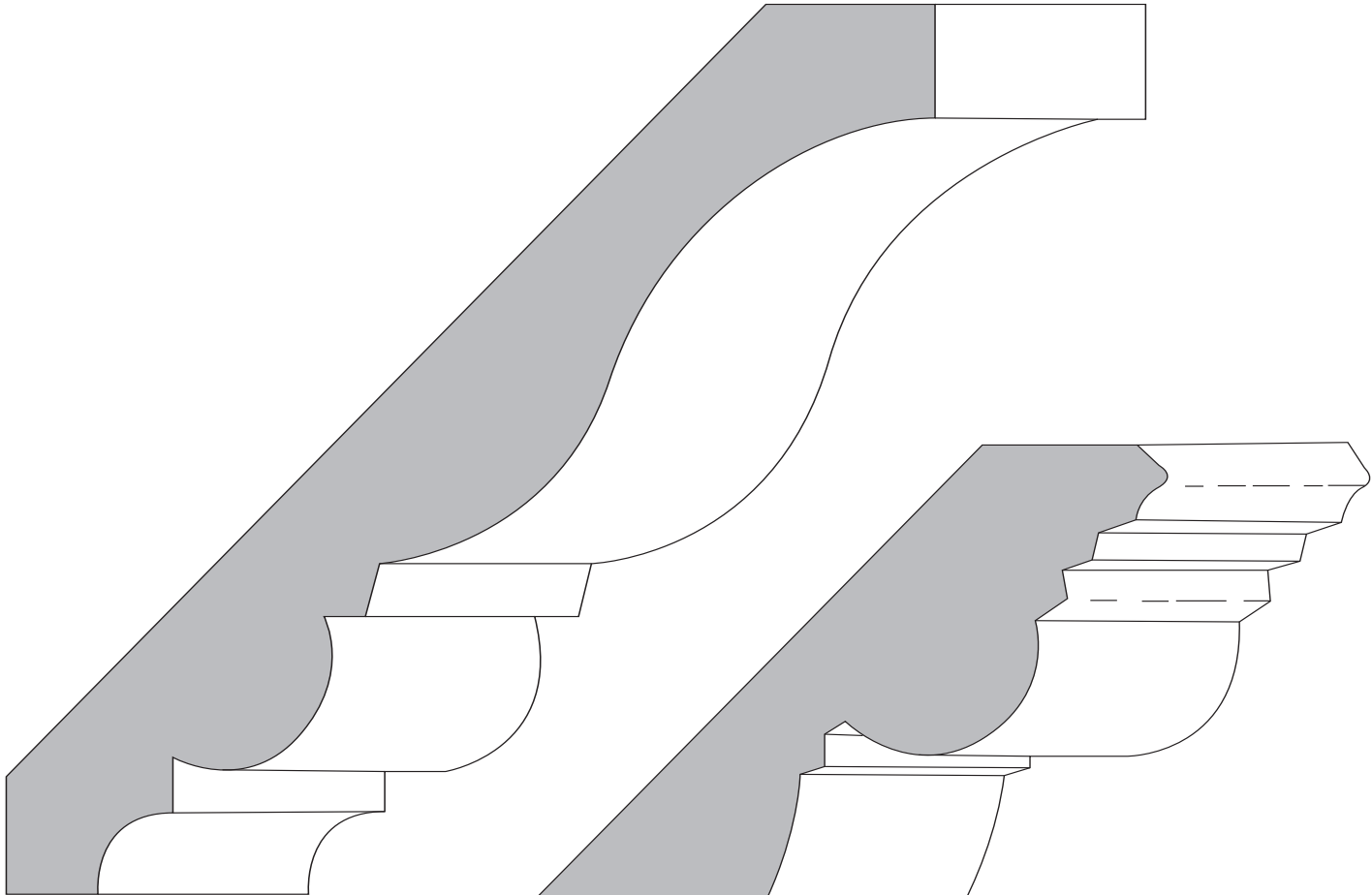

C-RR700
1 x 7

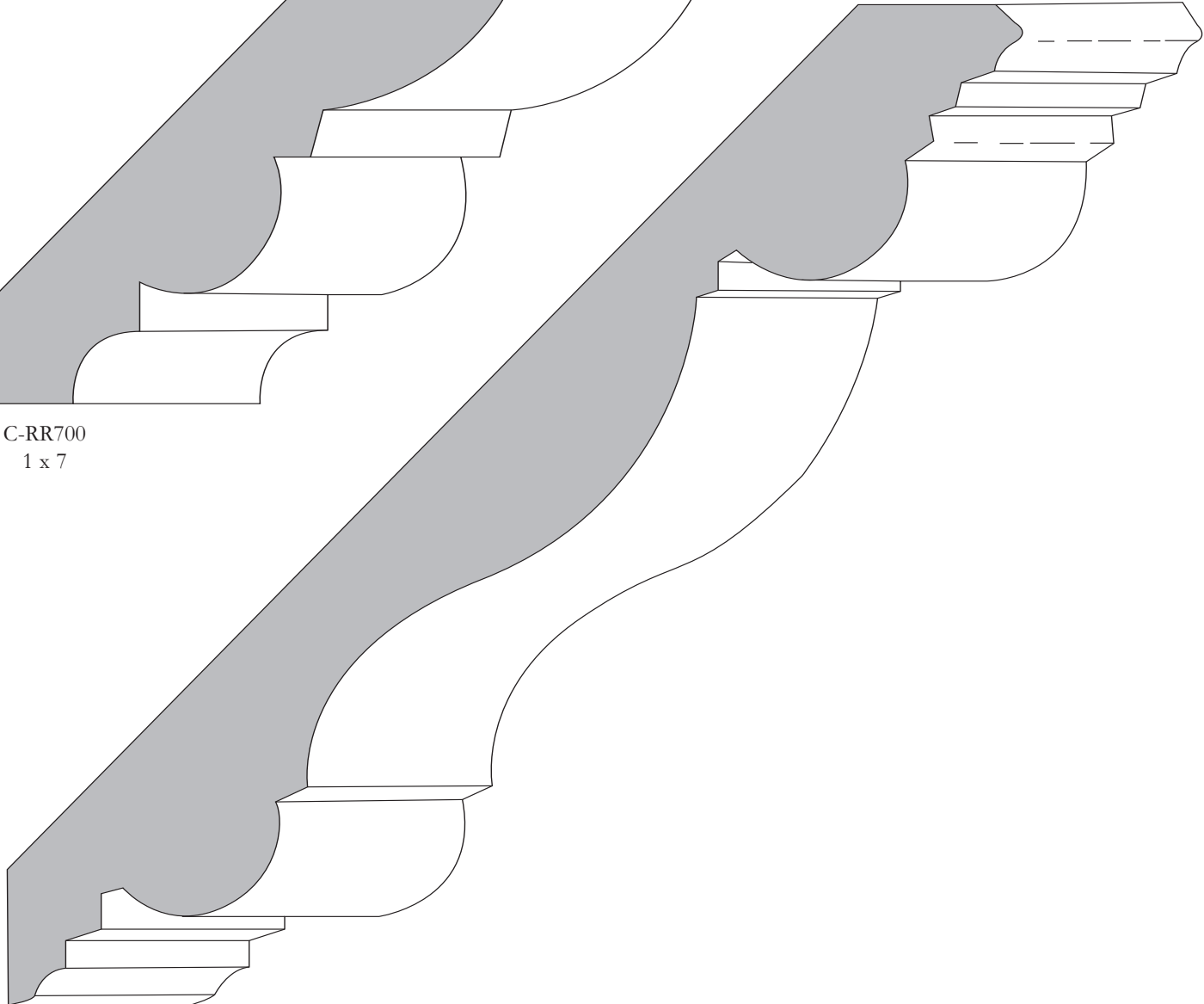

C-RC858
1 1/8 x 8 1/2



CROWN

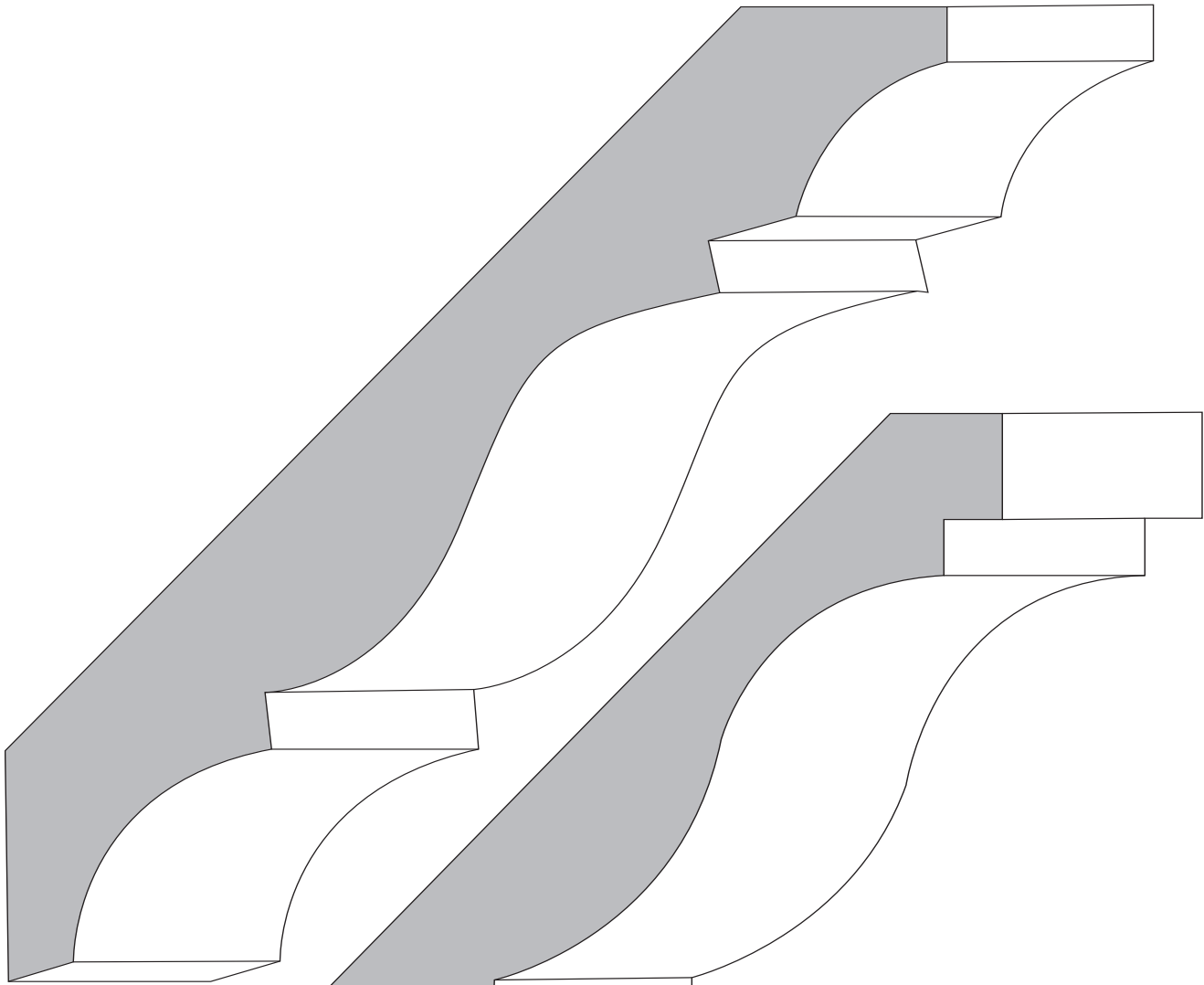

C-BM256
1¹/₈ x 7⁵/₁₆

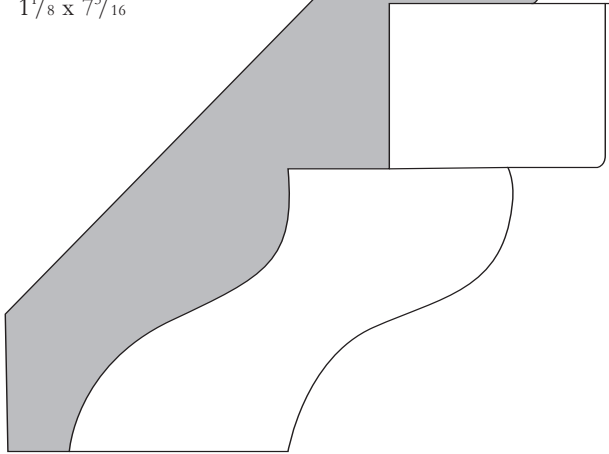

C-NA800
7⁷/₈ x 8



CROWN

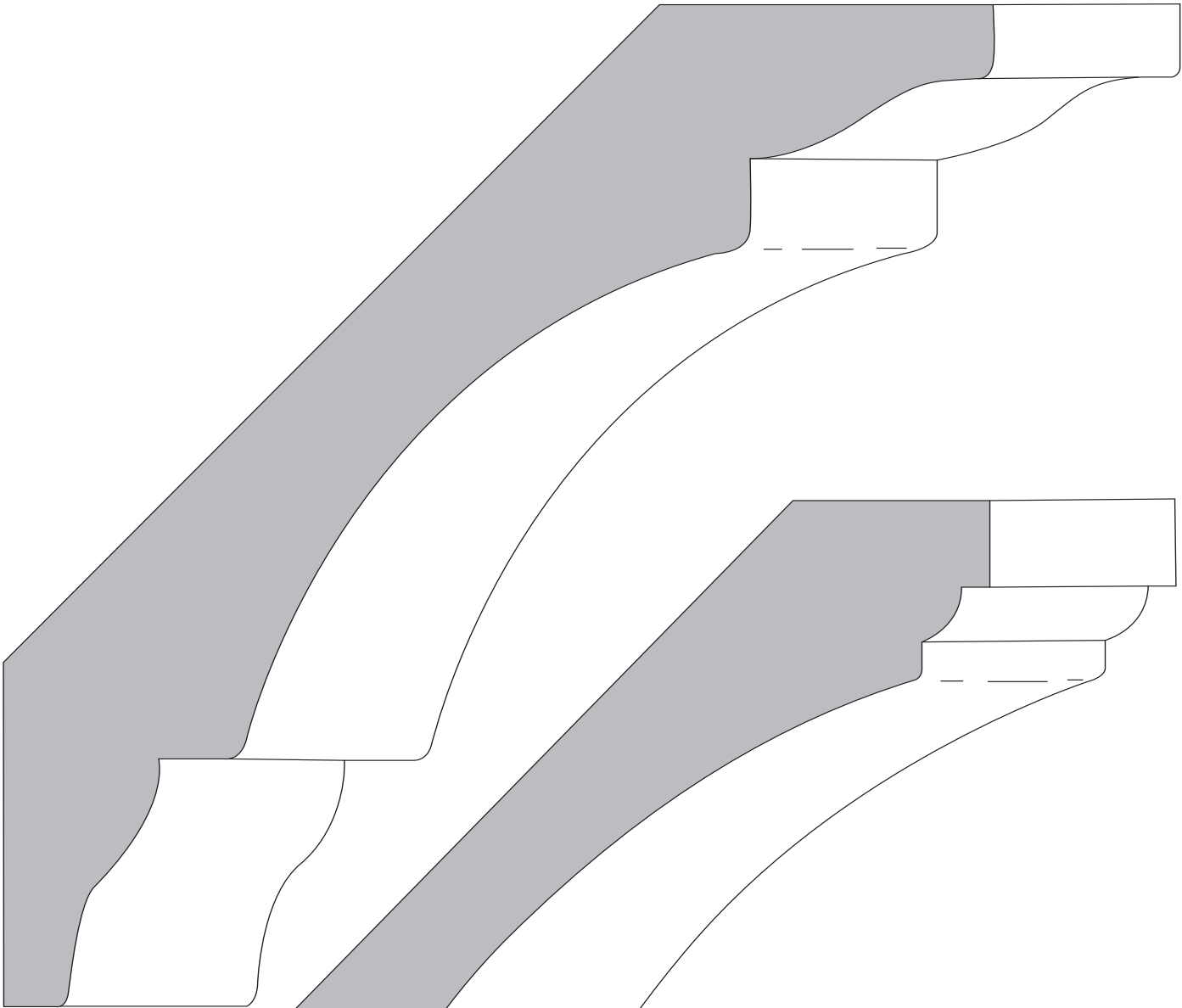

C-TH428
 $1\frac{3}{4} \times 8\frac{5}{8}$

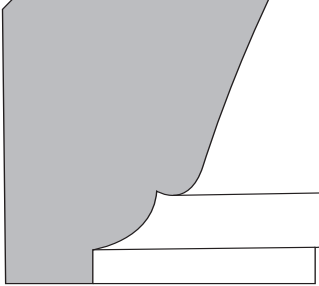

C-LD248
 $1\frac{5}{8} \times 7\frac{3}{4}$



CROWN

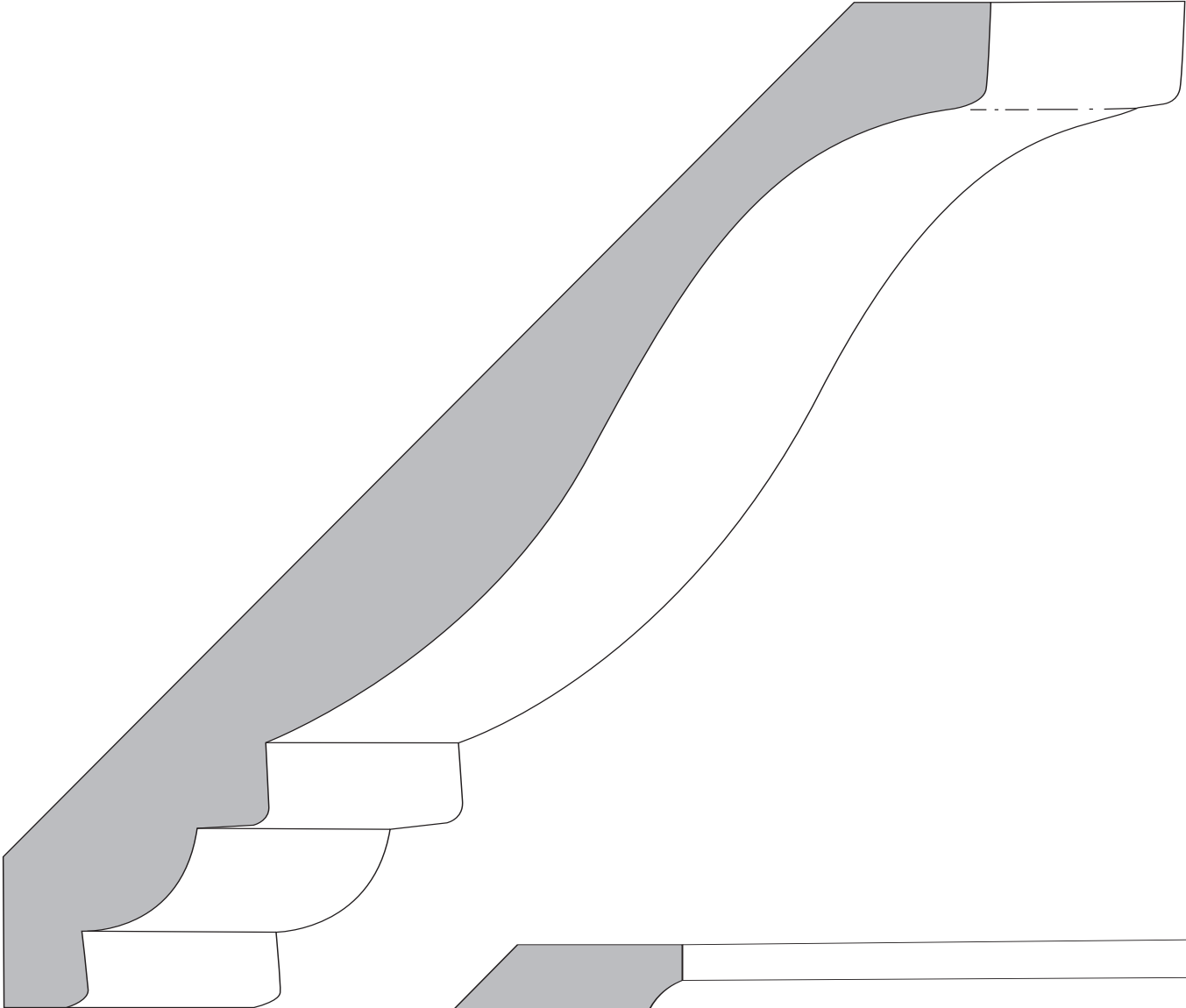

C-PM611
 $\frac{5}{16} \times 8\frac{1}{4}$

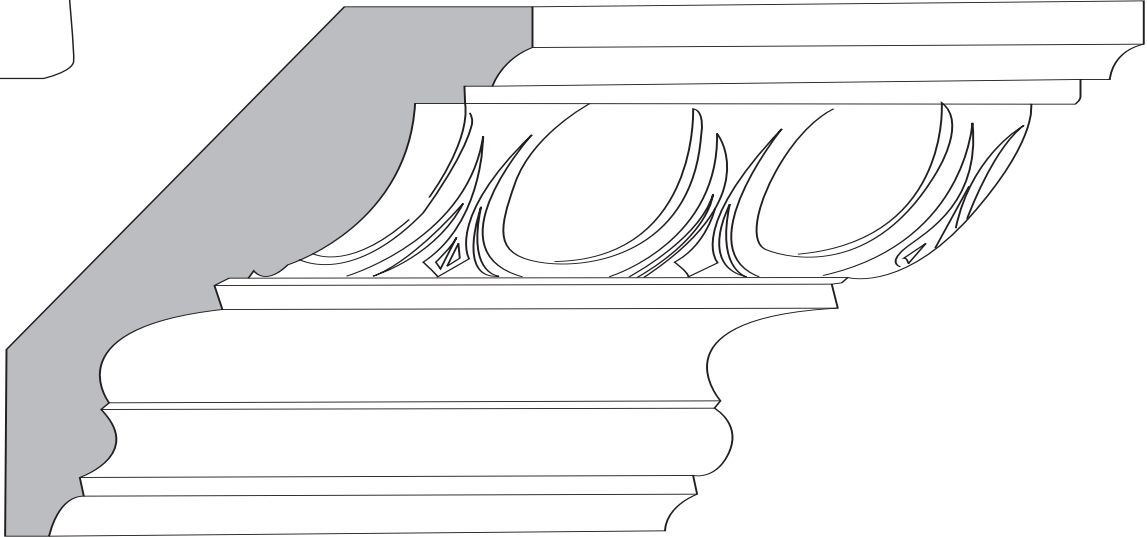

C-RR215
 $\frac{5}{16} \times 3\frac{3}{4}$

CROWN

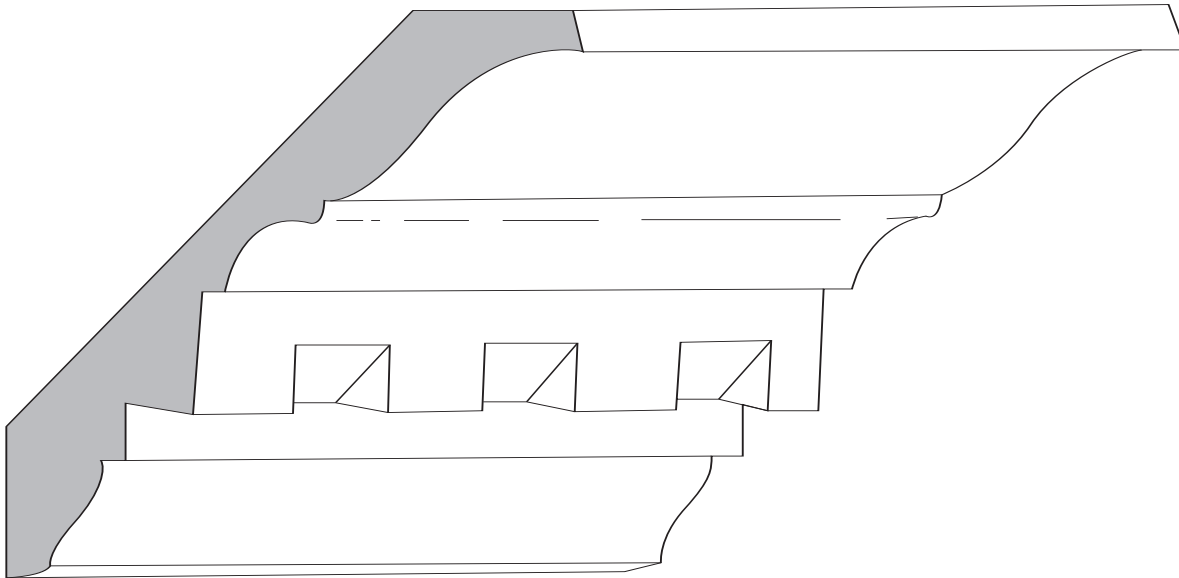

C-RL425
 $\frac{3}{4} \times 4\frac{1}{4}$

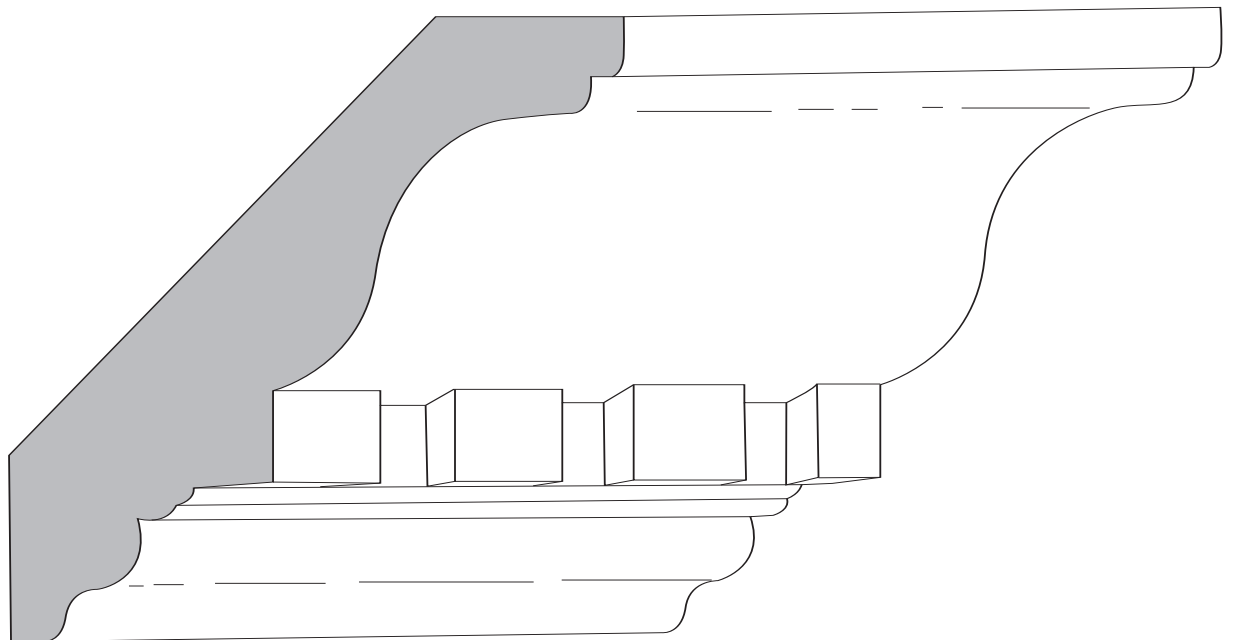

C-MD012
 $1\frac{1}{16} \times 4\frac{1}{2}$

CROWN

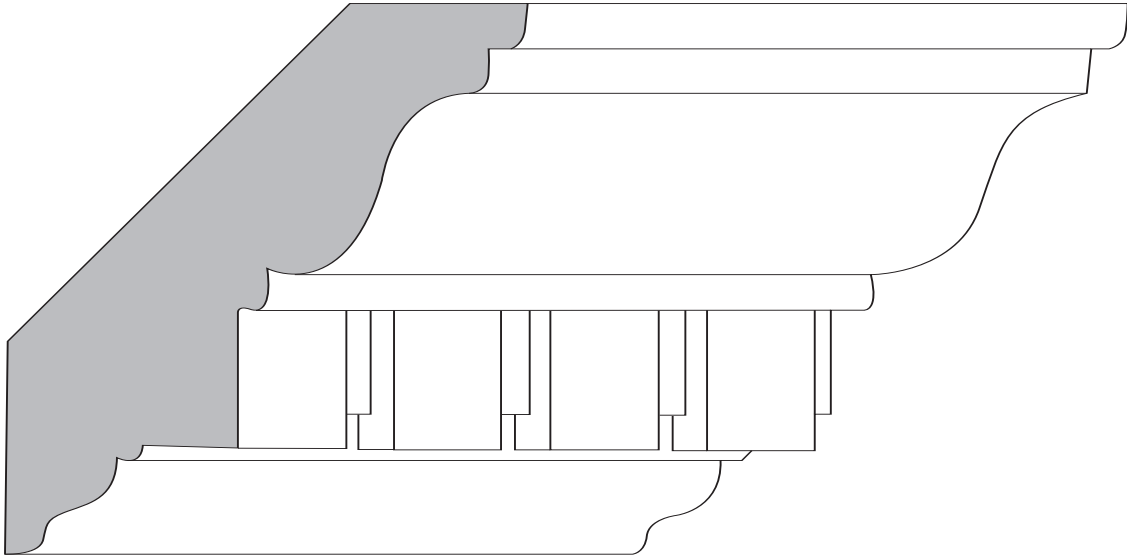

C-RR205
1³/₁₆ x 3⁷/₈

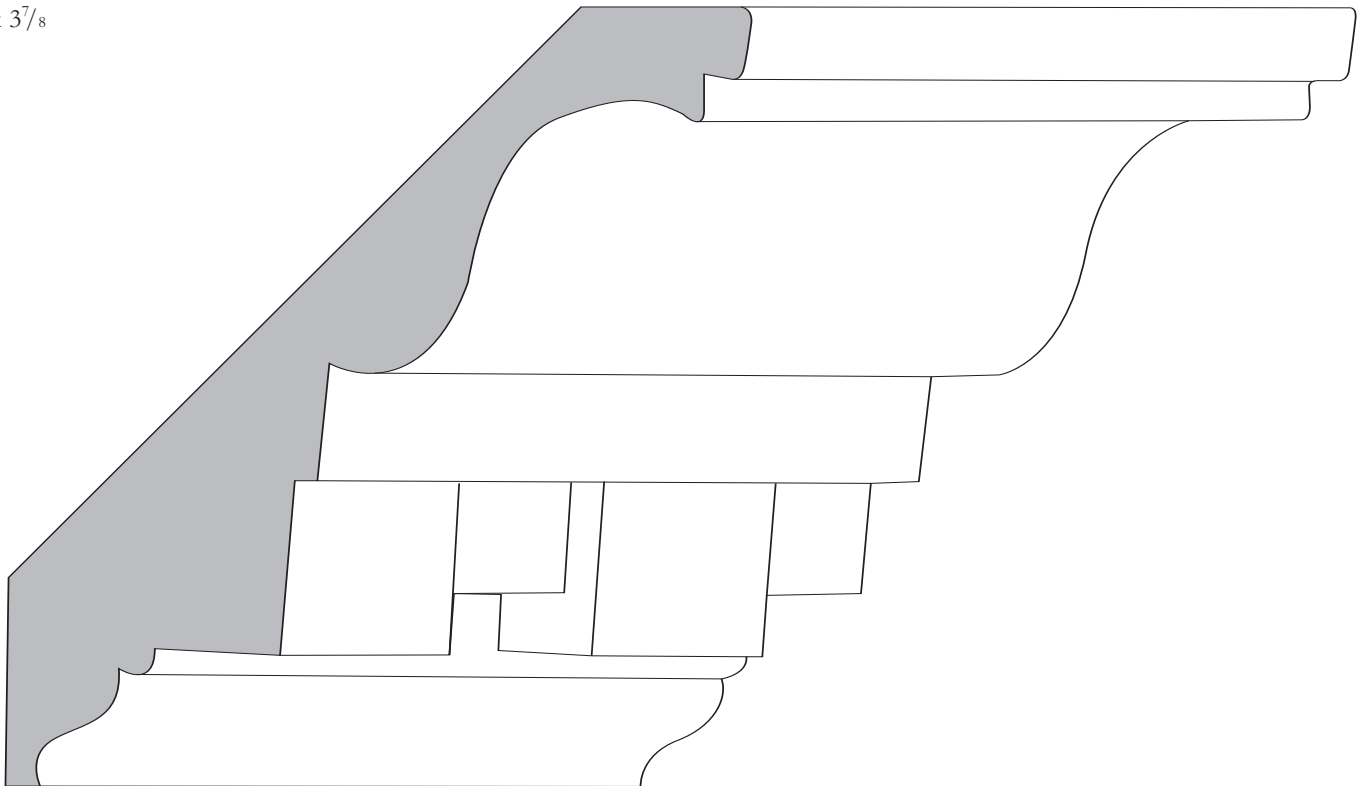

C-RR205
1³/₁₆ x 3⁷/₈

CROWN

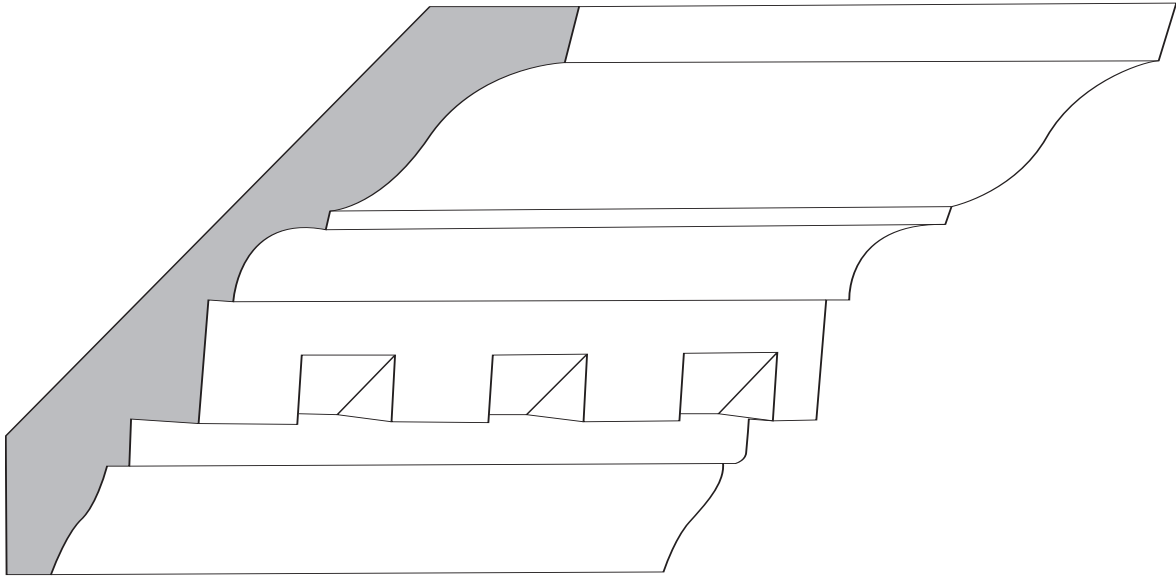

C-SS425
 $\frac{5}{8} \times 4\frac{1}{4}$

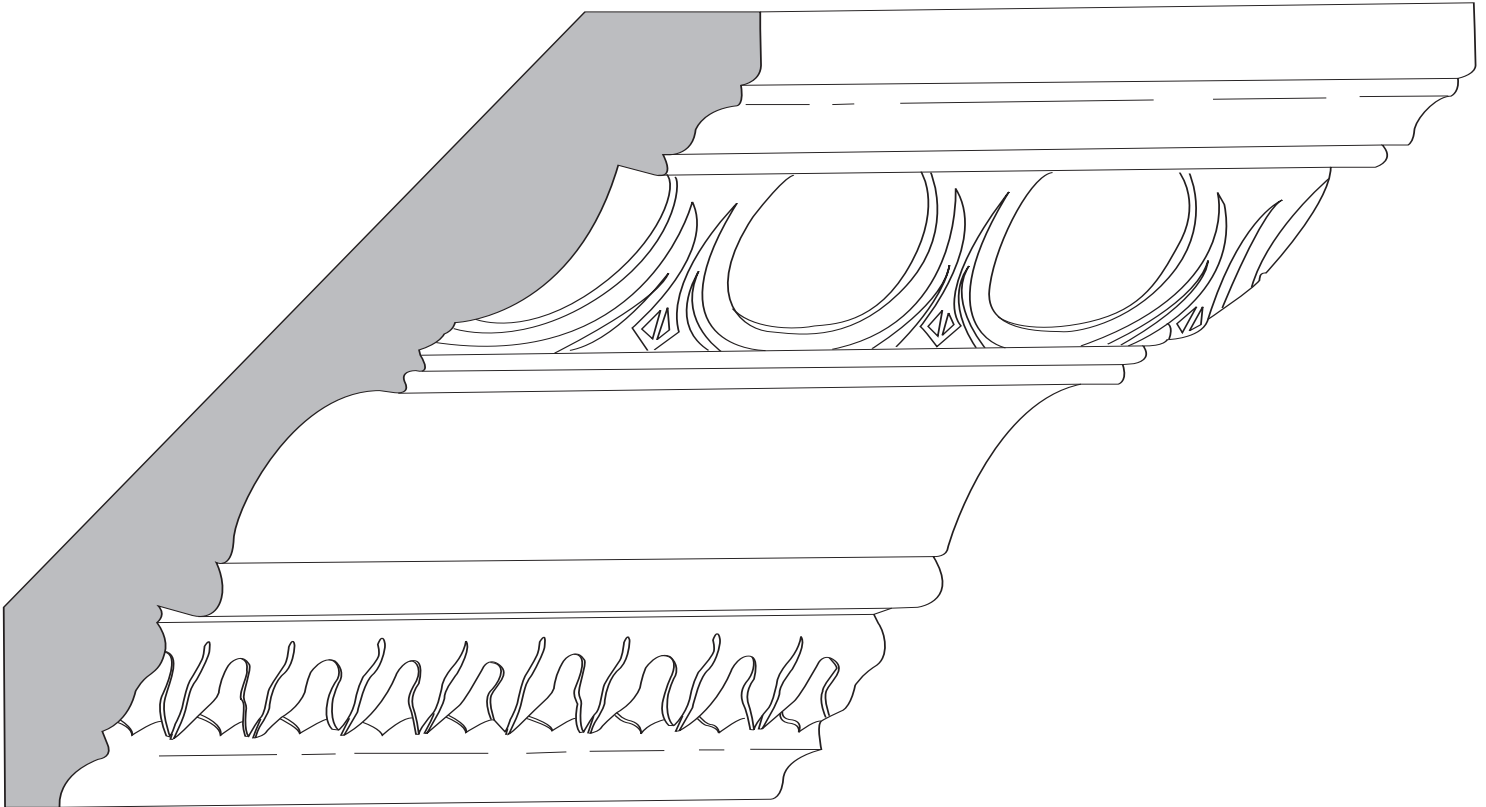

C-RR210
 $\frac{7}{8} \times 5\frac{3}{4}$

COVE / RABBETED PANEL

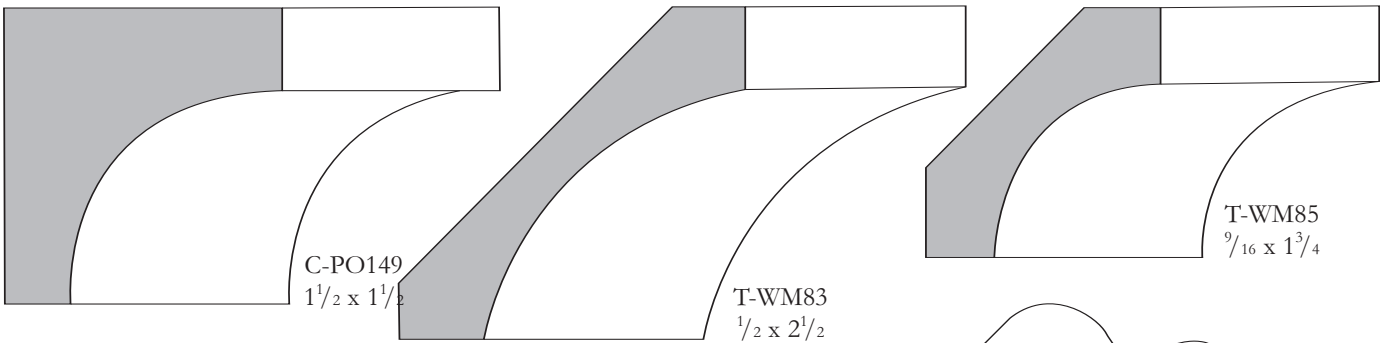
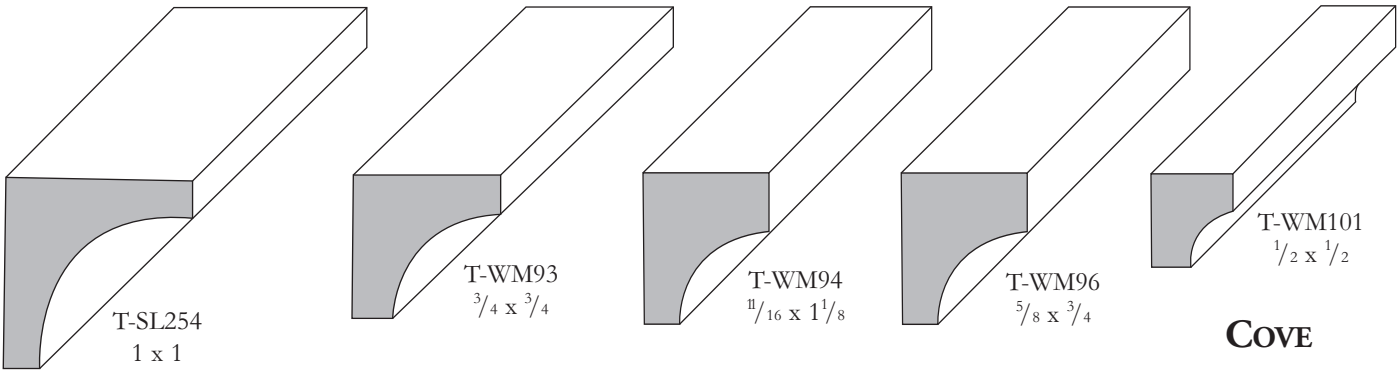

RABBETED PANEL

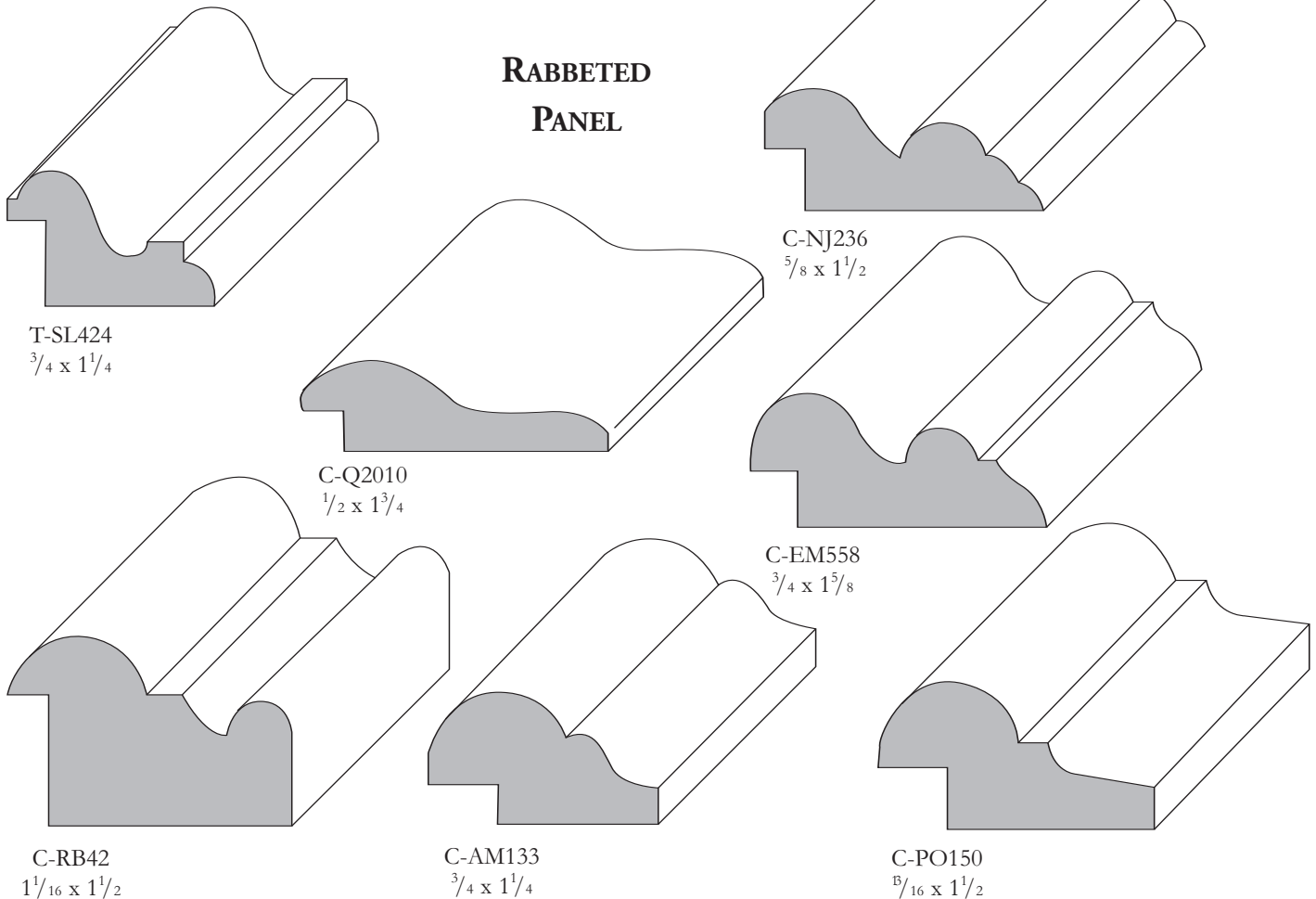

PANEL

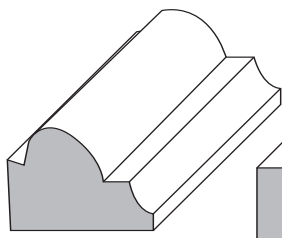

T-SL401
1/2 x 3/4

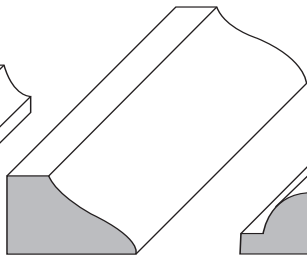

C-RRL06
3/8 x 5/8

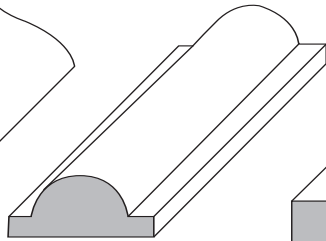

C-TH075
5/16 x 3/4

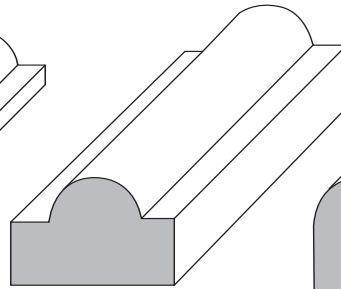

C-TH080
9/16 x 7/8

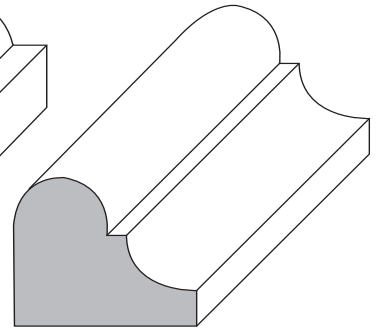

C-GM13
3/4 x 1

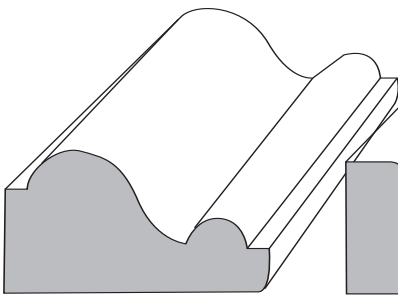

C-35955
11/16 x 1 5/16

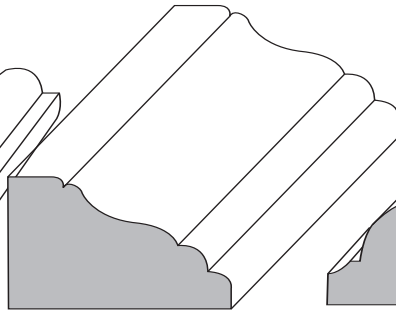

C-RRL07
5/8 x 1 1/8

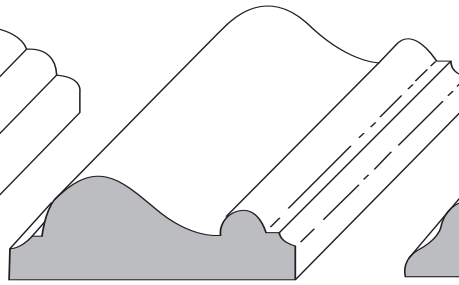

C-PS112
1/2 x 1 1/2

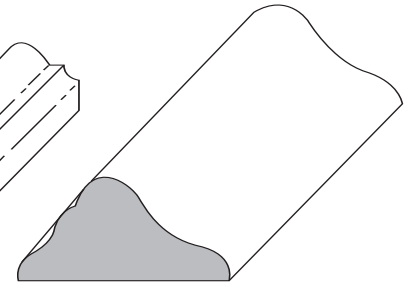

T-WM183
1/2 x 1 1/8

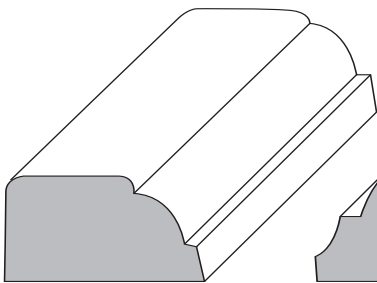

C-P9050
1/2 x 1

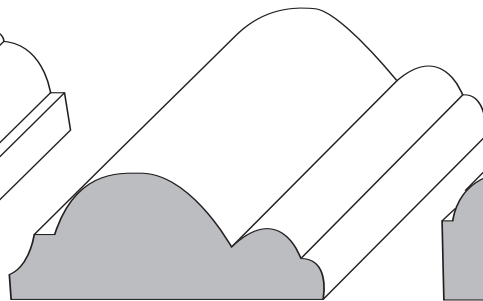

C-NJ918
11/16 x 1 5/8

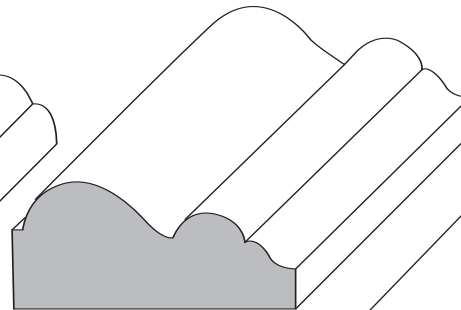

C-NJ232
11/16 x 1 3/8

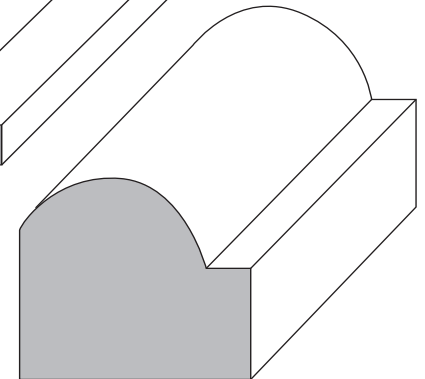

C-PO118
1 x 1 1/8

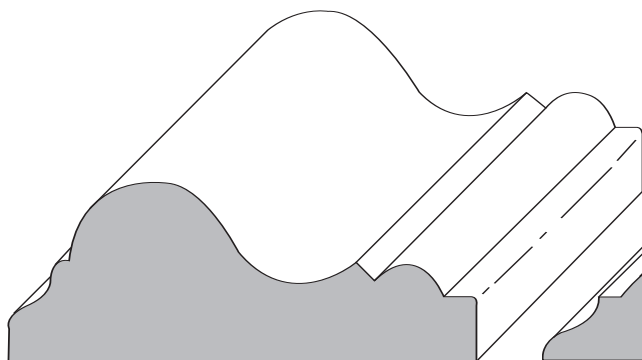

C-P8020
5/16 x 2 3/8

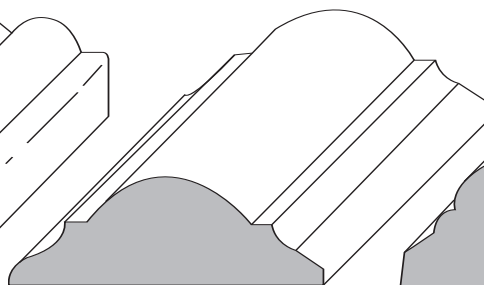

C-NJ425
1/2 x 1 5/8

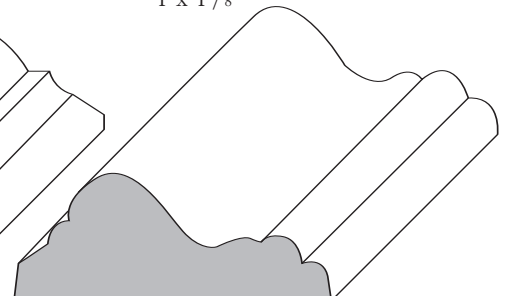

C-P8030
5/8 x 1 5/8



CHAIR RAIL

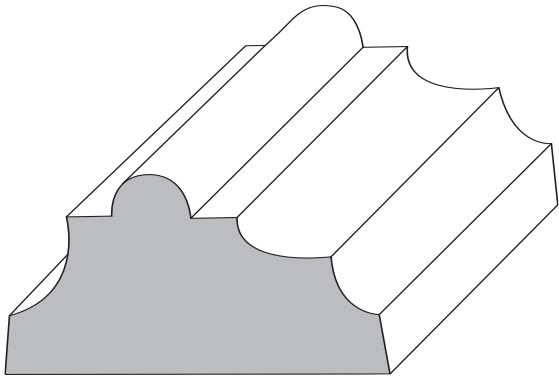

C-P9040
1 x 2

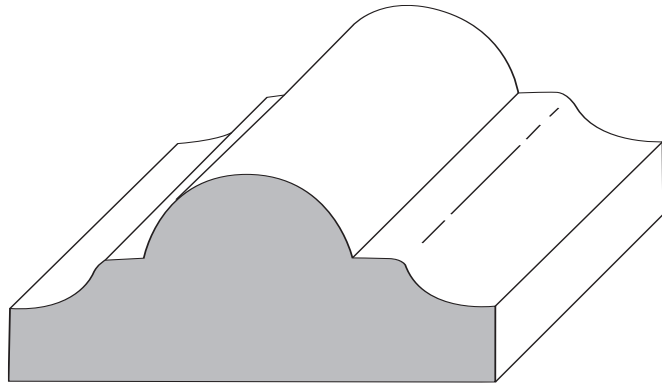

C-BO136
1¹/₁₆ x 2¹/₂

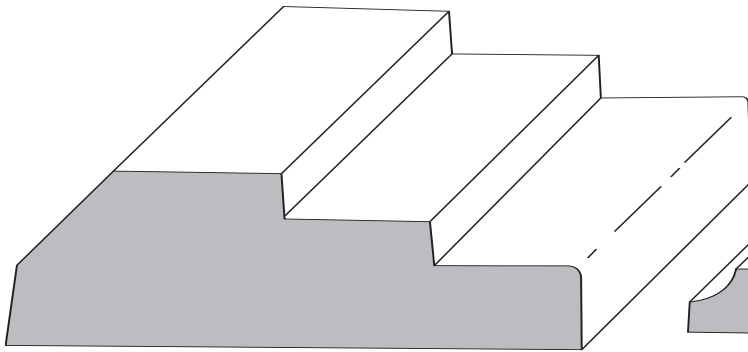

C-P7070
7/8 x 3

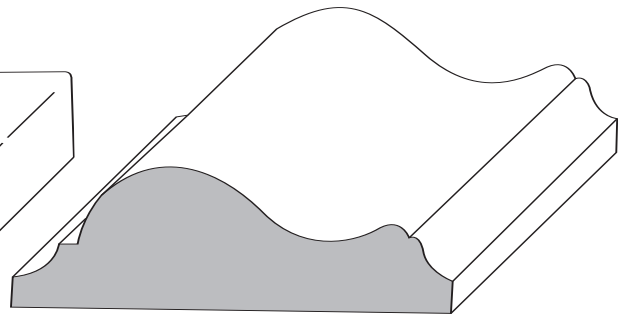

C-PM510
3/4 x 2¹/₄

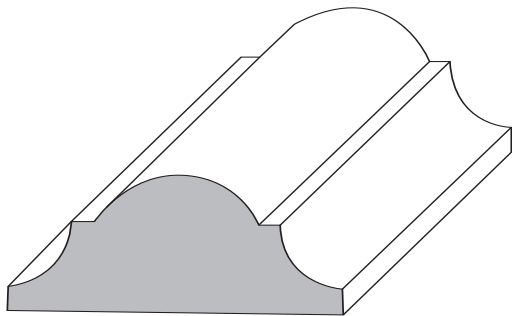

T-SL101
3/4 x 1³/₄

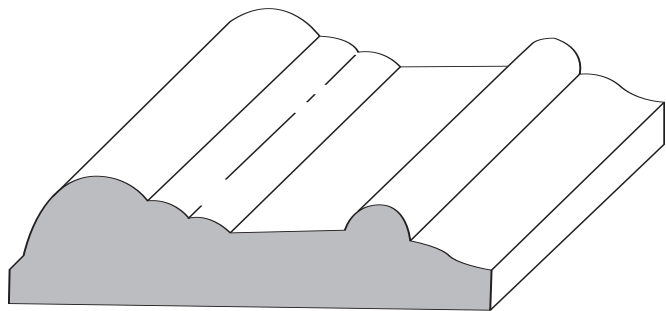

C-RLC10
1¹/₁₆ x 2¹/₂

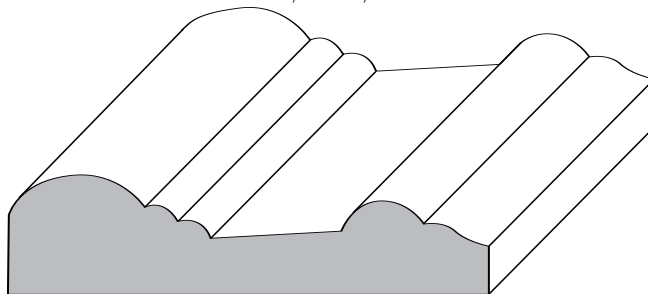

T-SL207
5/8 x 2¹/₂



CHAIR RAIL

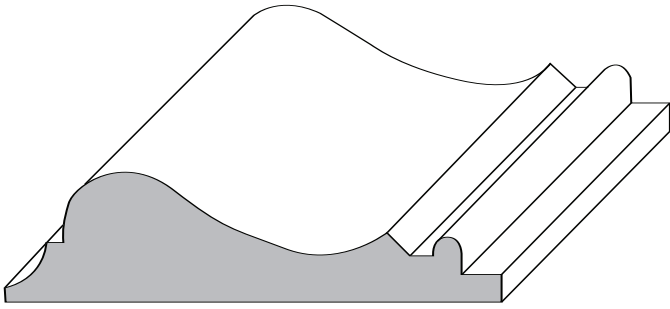

T-WM390
 $\frac{11}{16} \times 2\frac{5}{8}$

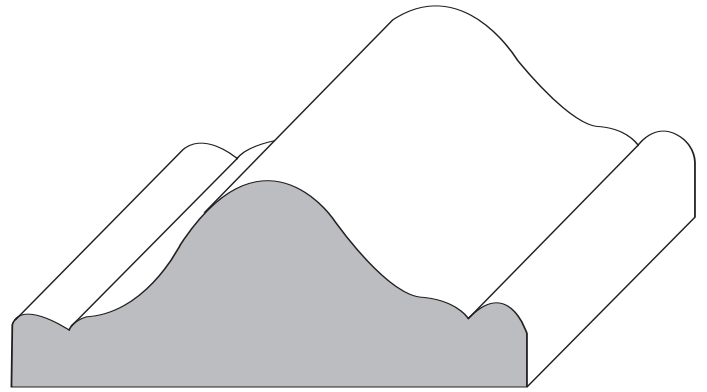

T-WM302
 $1\frac{1}{16} \times 2\frac{3}{4}$

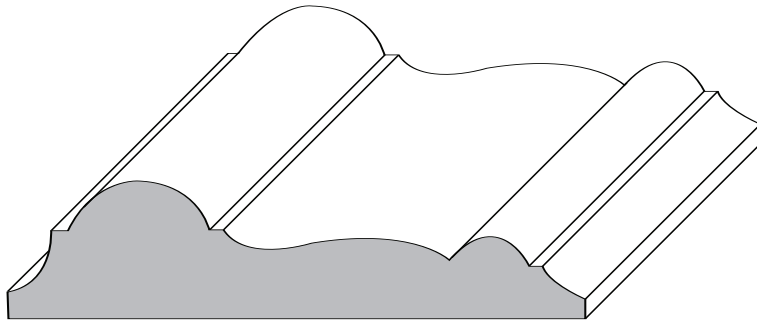

T-WM297
 $\frac{11}{16} \times 3$

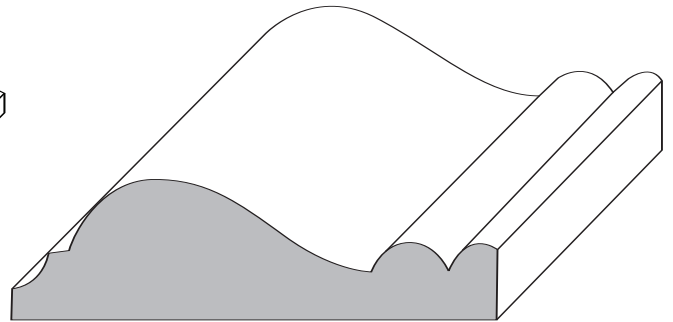

C-R242U
 $\frac{11}{16} \times 2\frac{1}{2}$

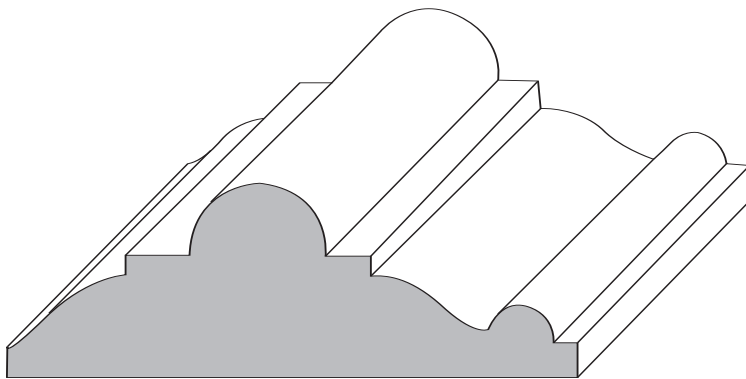

T-WM300
 1×3

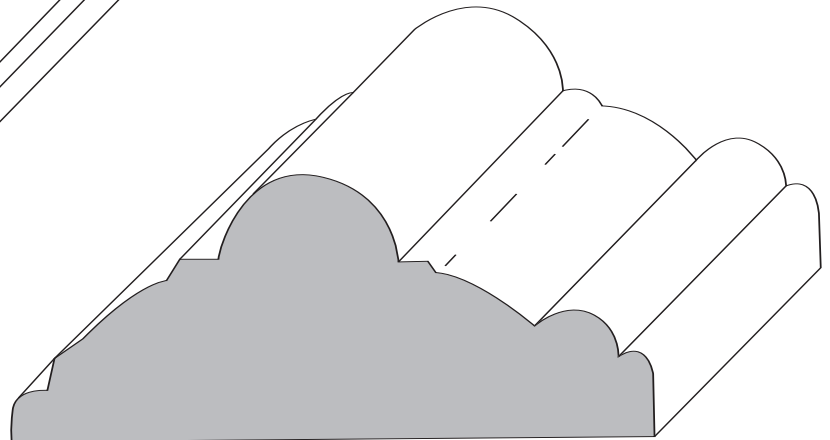

C-CT325
 $1\frac{3}{8} \times 3\frac{3}{16}$



CHAIR RAIL

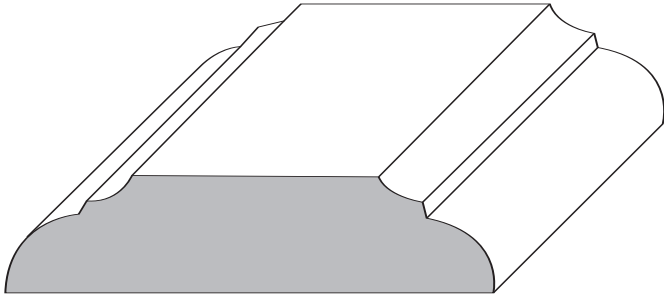

T-SL231
 $\frac{9}{16} \times 2\frac{1}{2}$

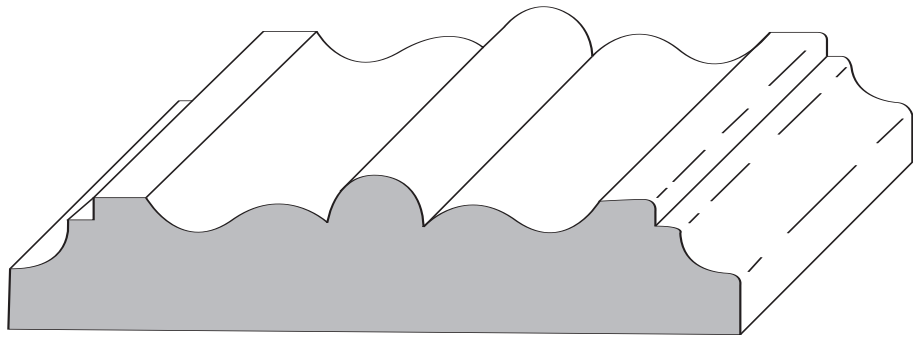

C-P9020
 $\frac{5}{16} \times 3\frac{3}{4}$

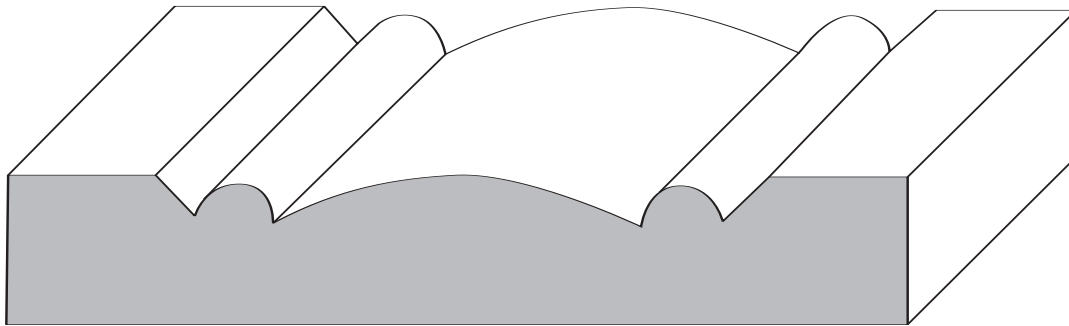

C-ES12P
 $\frac{3}{4} \times 4\frac{3}{8}$

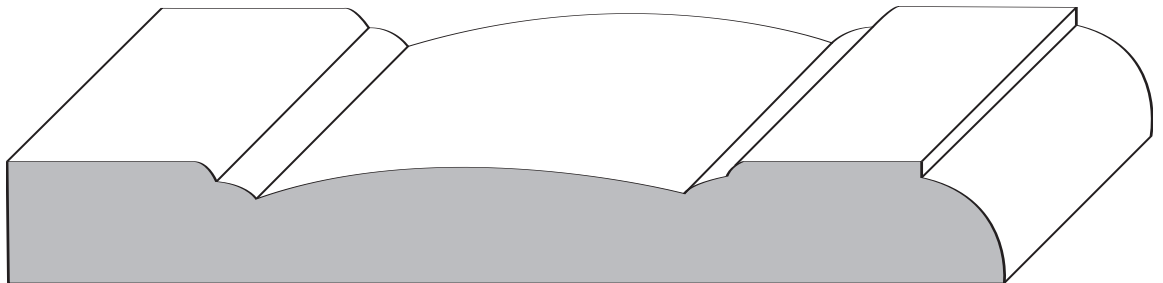

C-BA518
 $\frac{5}{8} \times 5\frac{1}{8}$

CHAIR RAIL

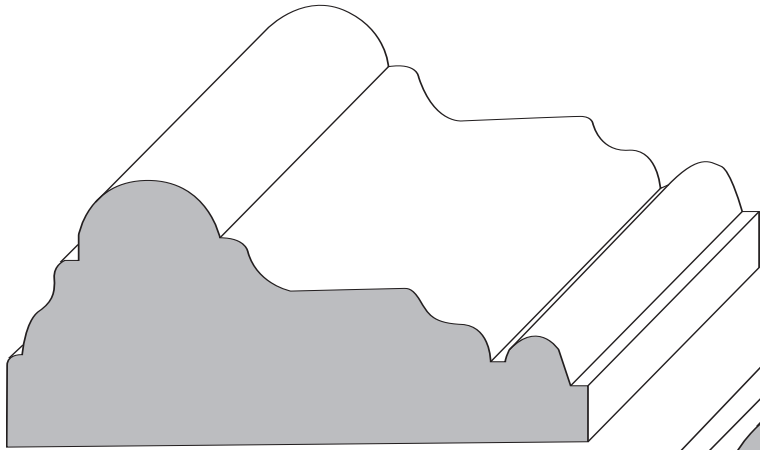

C-SI540
1⁵/₁₆ x 3

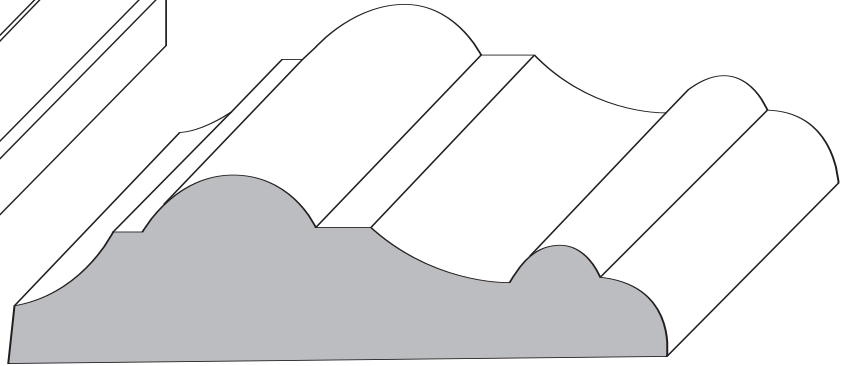

C-AH397
1¹/₈ x 3³/₈

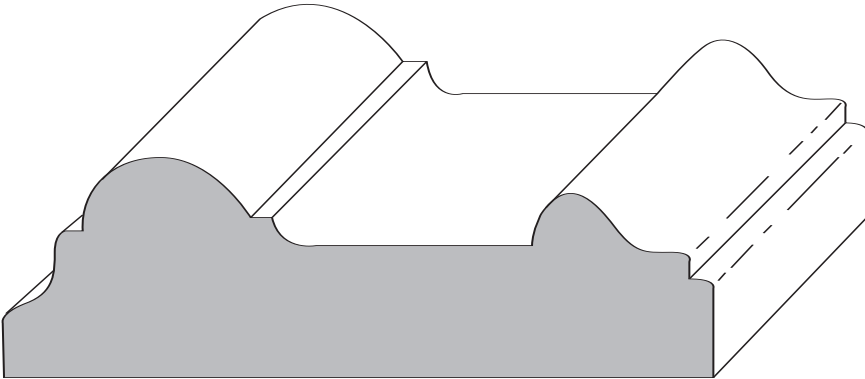

C-P9010
1¹/₈ x 3⁵/₈

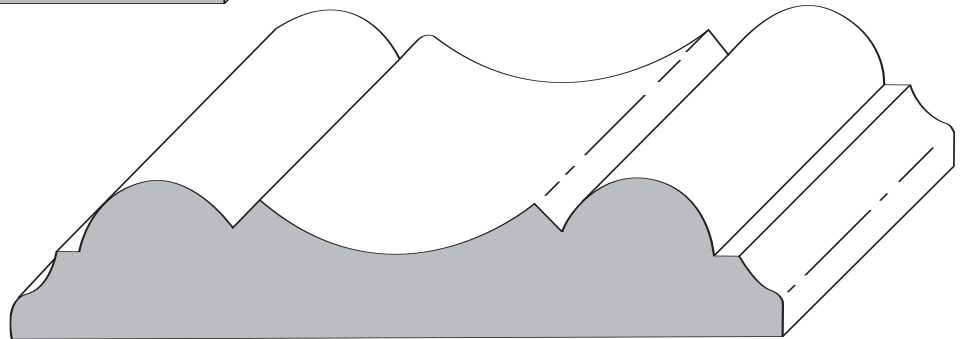

C-P8040
3³/₄ x 4

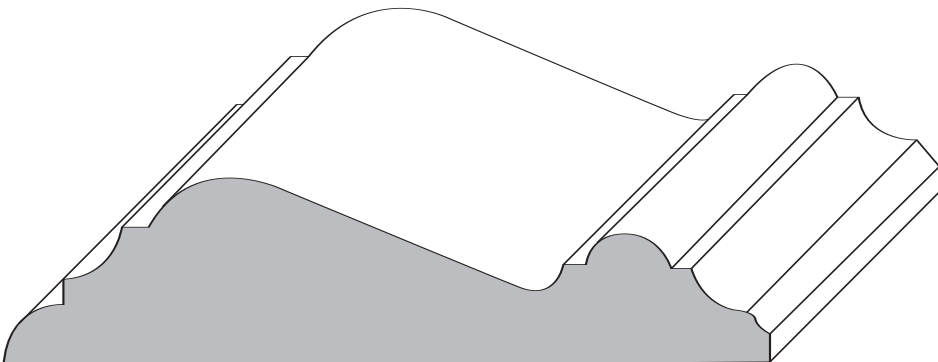

C-DS401
1 x 4



CHAIR RAIL BACKER

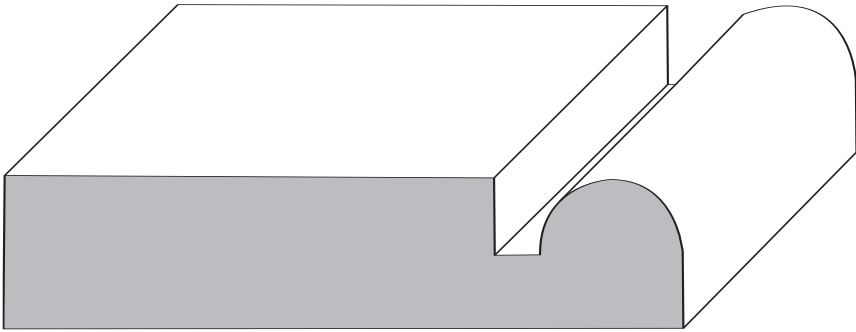

C-SM231
 $\frac{3}{4} \times 3\frac{1}{2}$

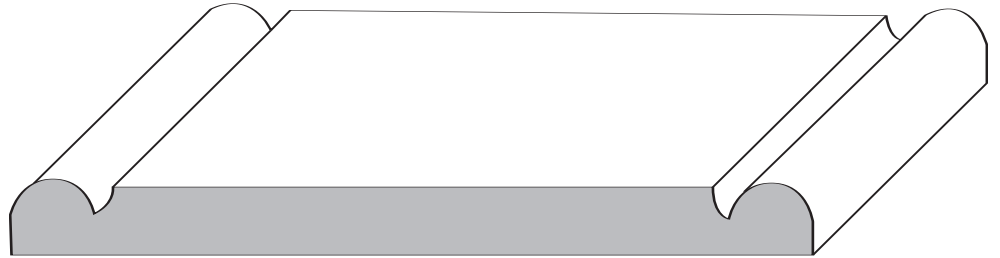

C-LO425
 $\frac{3}{8} \times 4\frac{1}{8}$



C-BO135
 $\frac{1}{2} \times 4\frac{1}{2}$



C-SM304
 $\frac{5}{8} \times 4\frac{1}{2}$

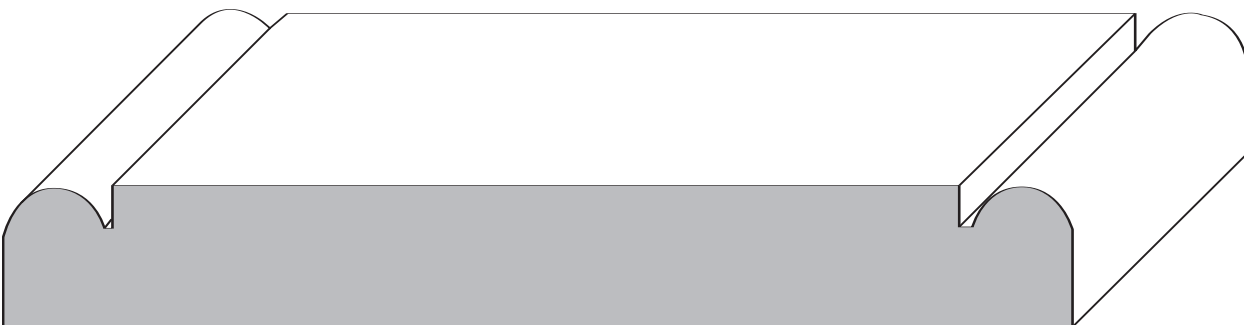

C-SE13
 $\frac{3}{4} \times 5\frac{1}{2}$



MISCELLANEOUS

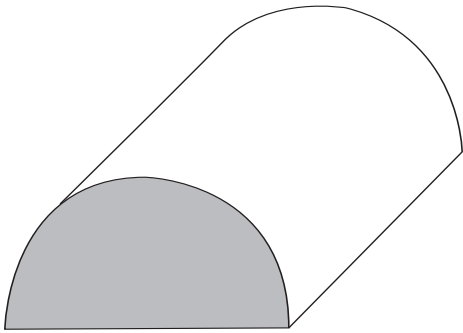

C-NJ714
3/4 x 1 1/2

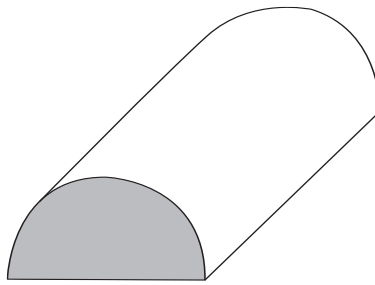

T-WM120
1/2 x 1

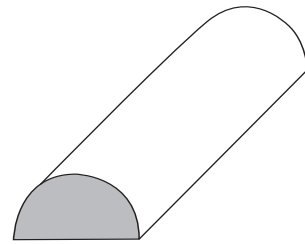

T-WM123
5/16 x 5/8

HALF ROUND

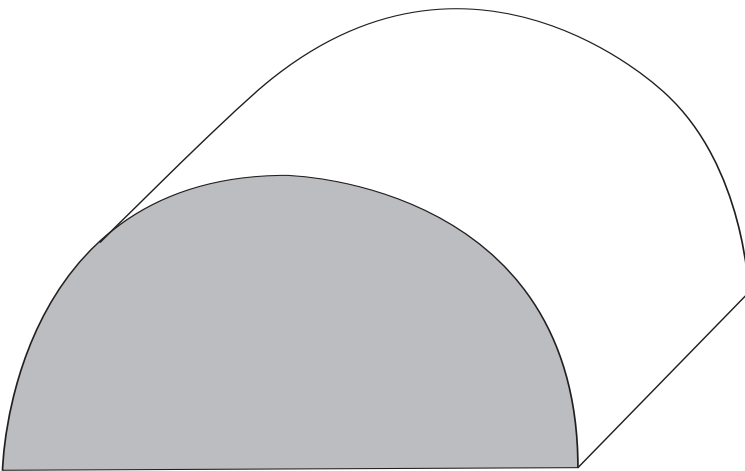

T-1.5 x 3
1 1/2 x 3

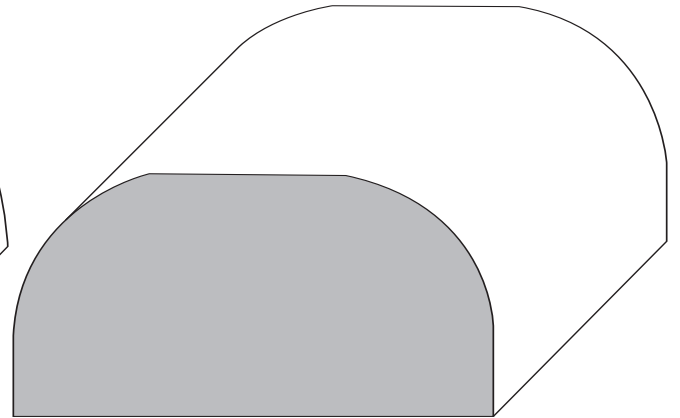

C-SM250
1 1/4 x 2 1/2

QUARTER ROUND

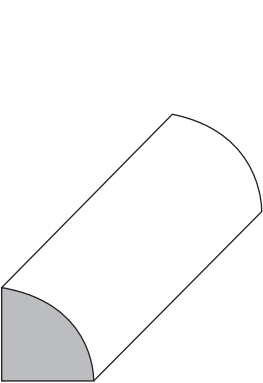

T-WM108
1/2 x 1/2

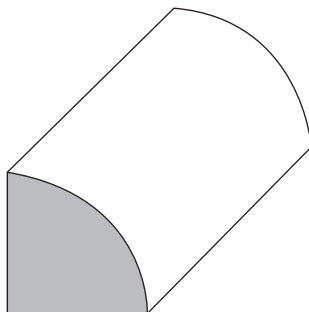

T-WM105
3/4 x 3/4

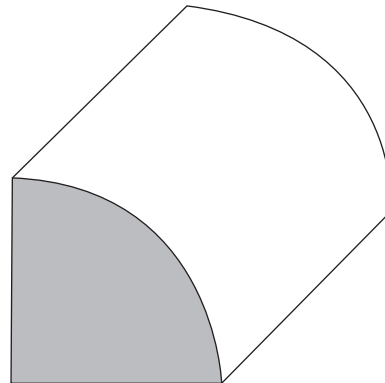

T-WM103
1 1/16 x 1 1/16



MISCELLANEOUS

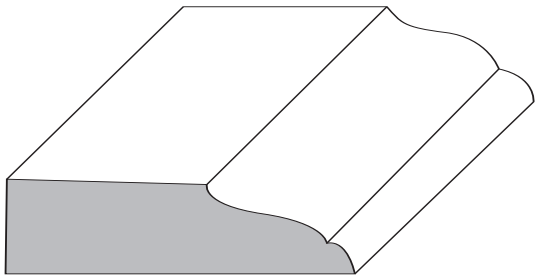

T-SL303
1/2 x 1 3/4

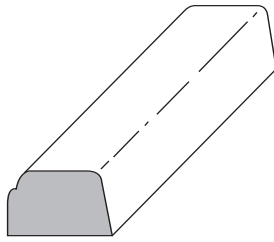

T-WS050
3/8 x 1/2

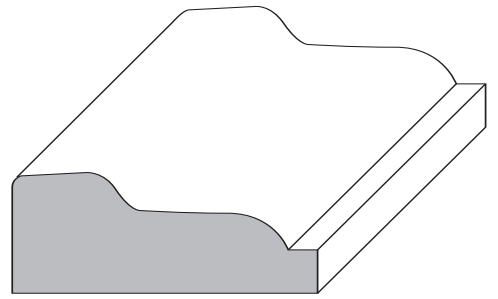

T-WM210
5/8 x 1 5/8

SHINGLE

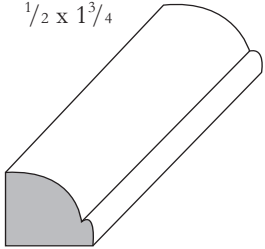

C-WS045
3/8 x 1/2

STOP

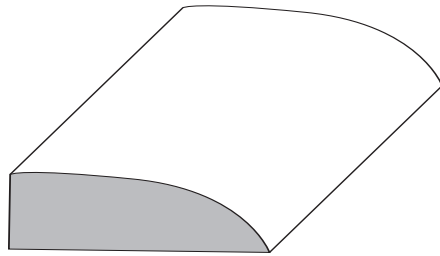

T-WM826
3/8 x 1 3/8

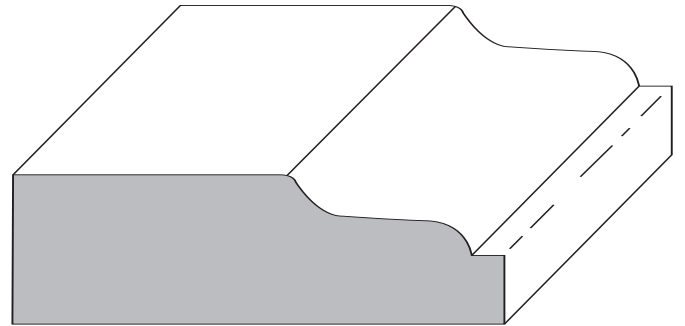

T-WM207
3/4 x 2 1/2

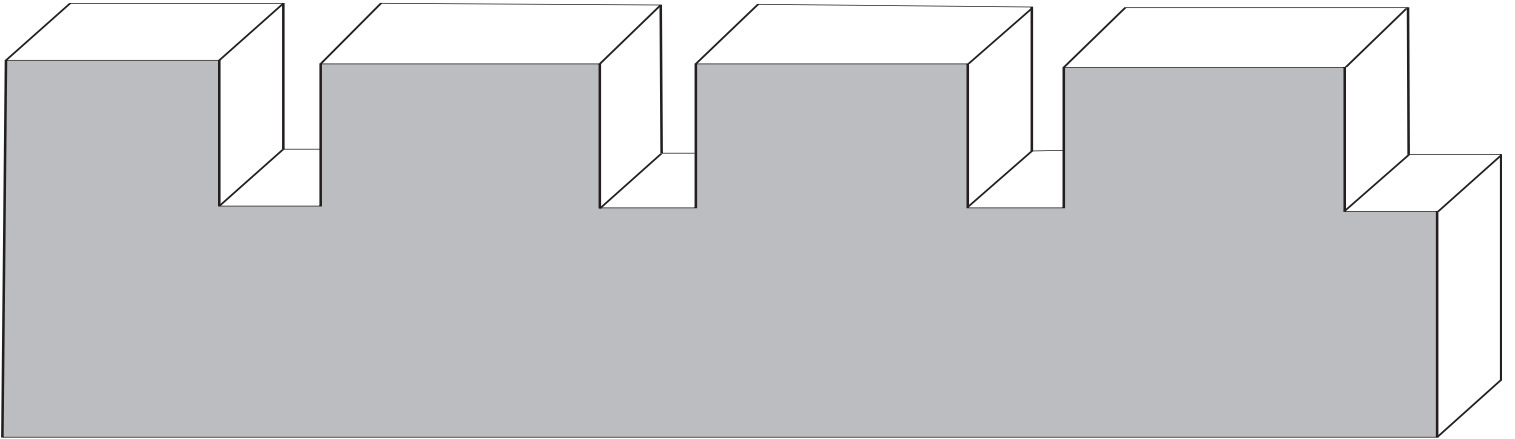

C-DN200
1/2 x 2

DENTIL

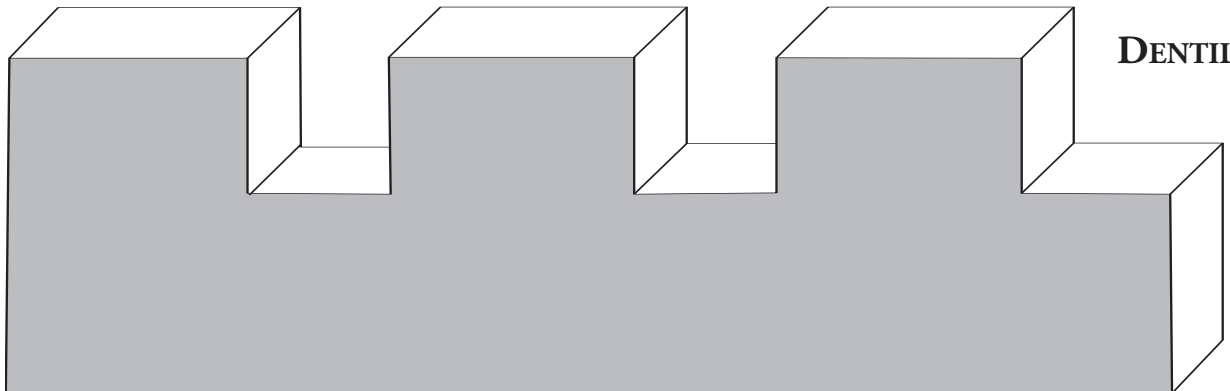

C-DN175
1/2 x 1 3/4



MISCELLANEOUS

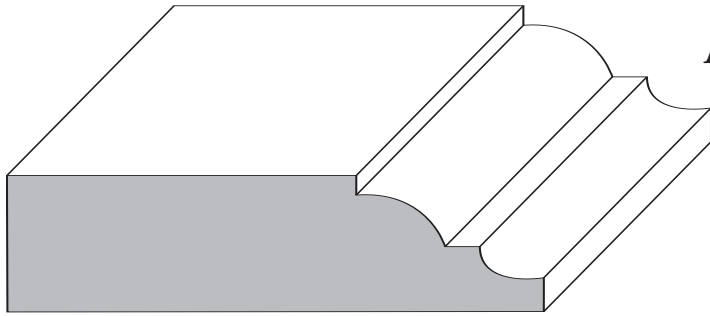

C-SMM89
3/4 x 2 3/4

APRON

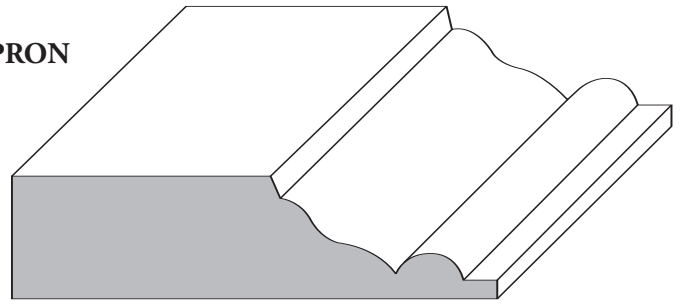

T-RB2
5/8 x 2 1/2

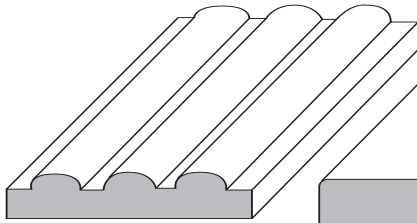

C-ST31B
1/4 x 1 1/4

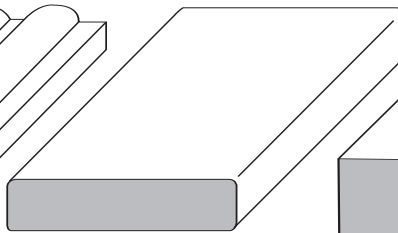

T-WM26B
1/4 x 1 3/16

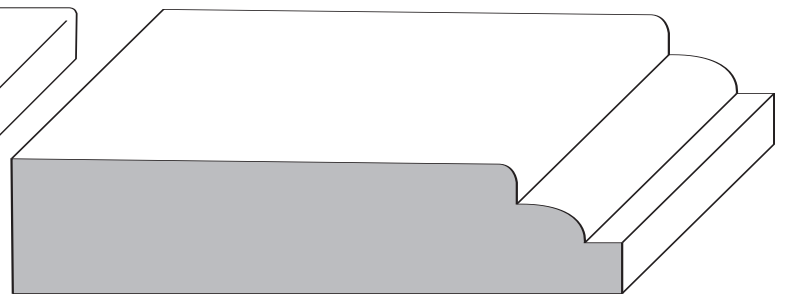

C-TC350
3/4 x 3 1/2

INSERT

LATTICE

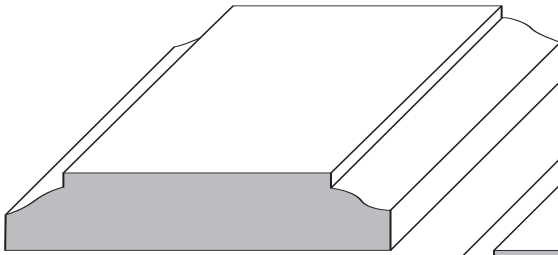

T-WM987
3/8 x 2

MULLION

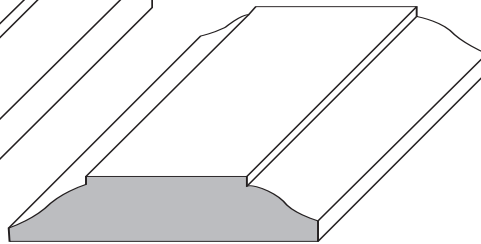

C-LW983
5/16 x 1 5/8

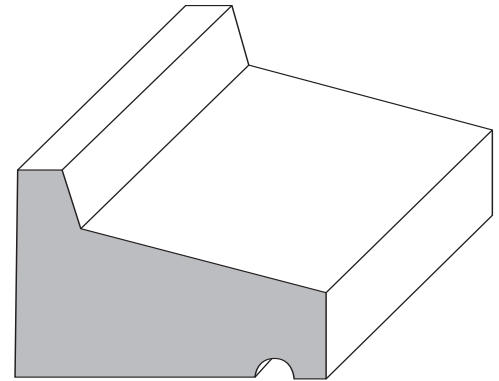

T-NC500
1 1/16 x 1 5/8

DRIP CAP

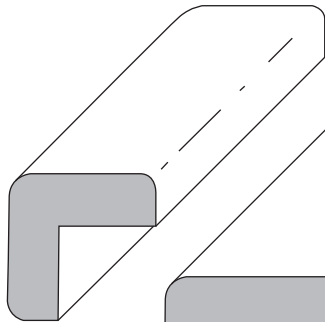

T-WM206
11/16 x 11/16

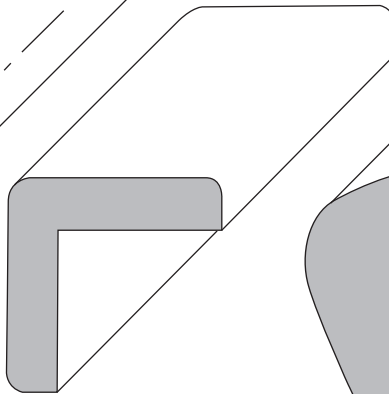

T-WM205
1 1/16 x 1 1/16

OUTSIDE CORNERS

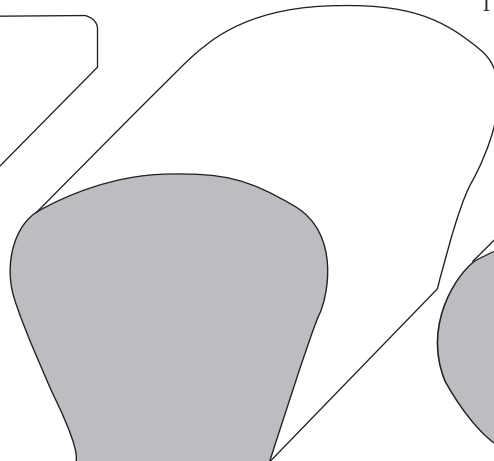

T-WM230
1 1/2 x 1 11/16

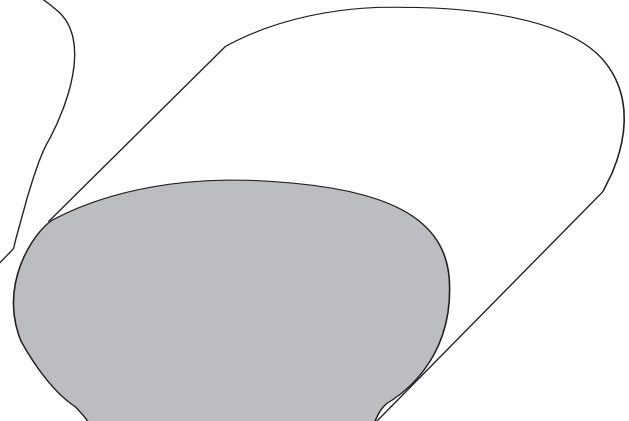

T-WM240
1 1/4 x 2 1/4

HAND RAIL



MISCELLANEOUS

RADIUS BASE CORNERS

Custom Radius Base Corners are designed to be used on $\frac{3}{4}$ " radius drywall corners and are available for any base profile desired.

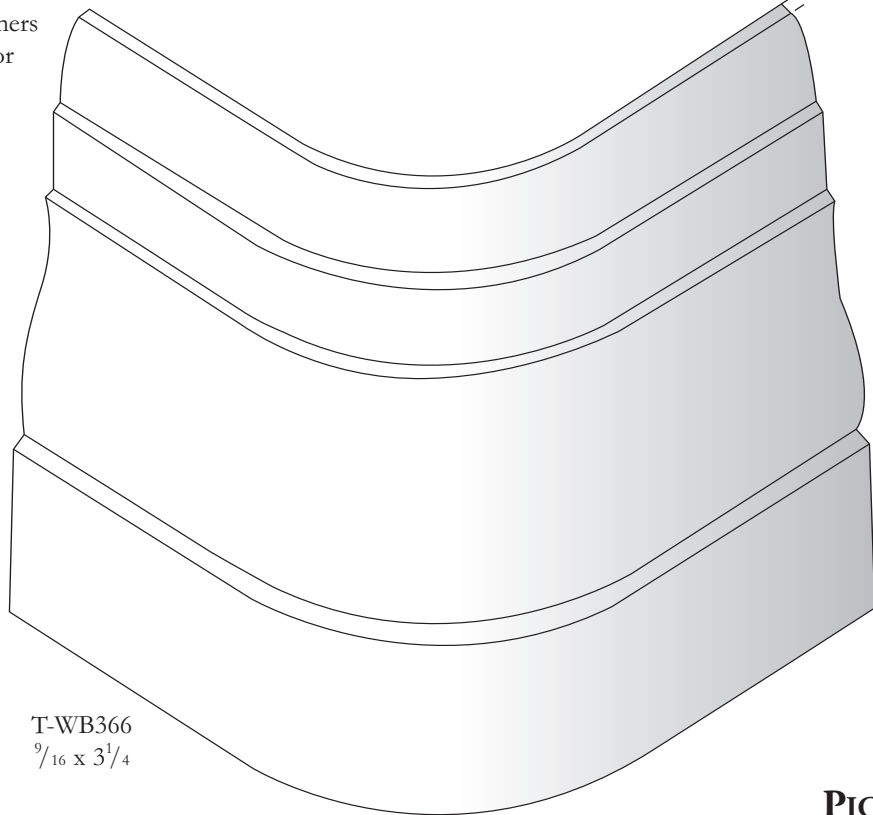

T-WB366
 $\frac{9}{16} \times 3\frac{1}{4}$

PICTURE MOULDING

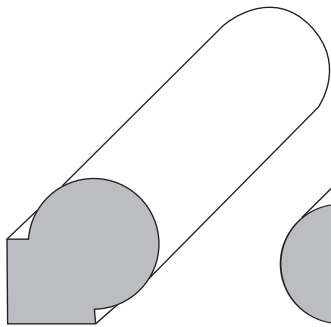

C-HA100
 $\frac{3}{4} \times \frac{3}{4}$

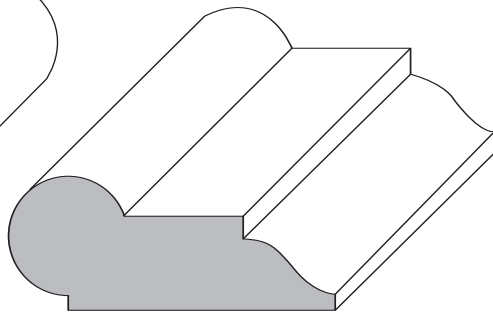

T-WM273
 $\frac{11}{16} \times 1\frac{11}{16}$

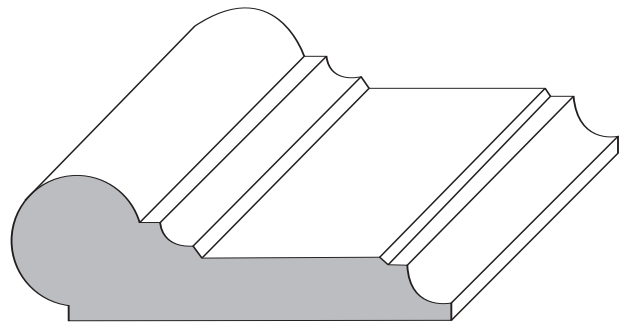

C-D1210
 $\frac{3}{4} \times 2\frac{1}{4}$

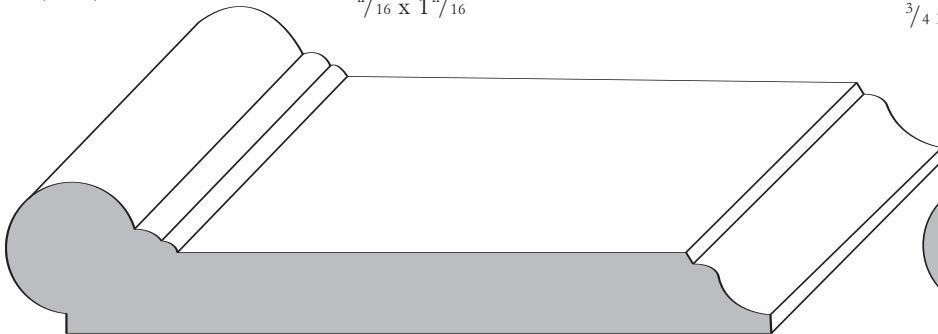

C-24128
 $\frac{3}{4} \times 4$

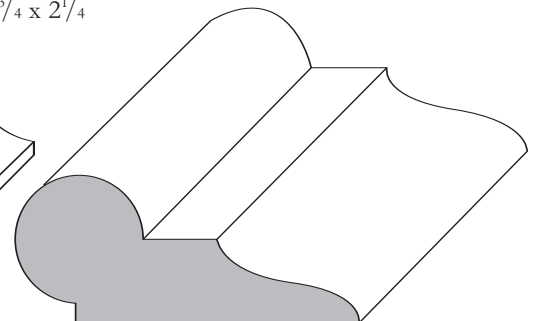

T-WM276
 $\frac{3}{4} \times 1\frac{3}{4}$



MISCELLANEOUS

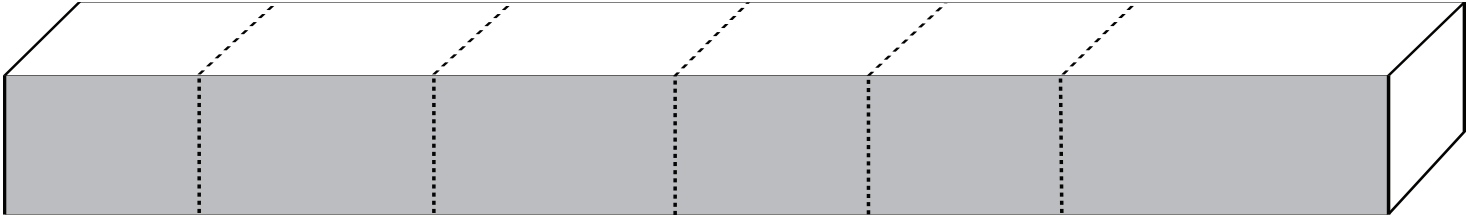

C-FC341 $\frac{3}{4} \times 1$
 T-1 x 225 $\frac{3}{4} \times 2\frac{1}{4}$
 T-WM1 x 4 $\frac{3}{4} \times 3\frac{1}{2}$
 T-WM1 x 5 $\frac{3}{4} \times 4\frac{1}{2}$
 T-WM1 x 6 $\frac{3}{4} \times 5\frac{1}{2}$
 T-WM1 x 8 $\frac{3}{4} \times 7\frac{1}{4}$
FLATSTOCK

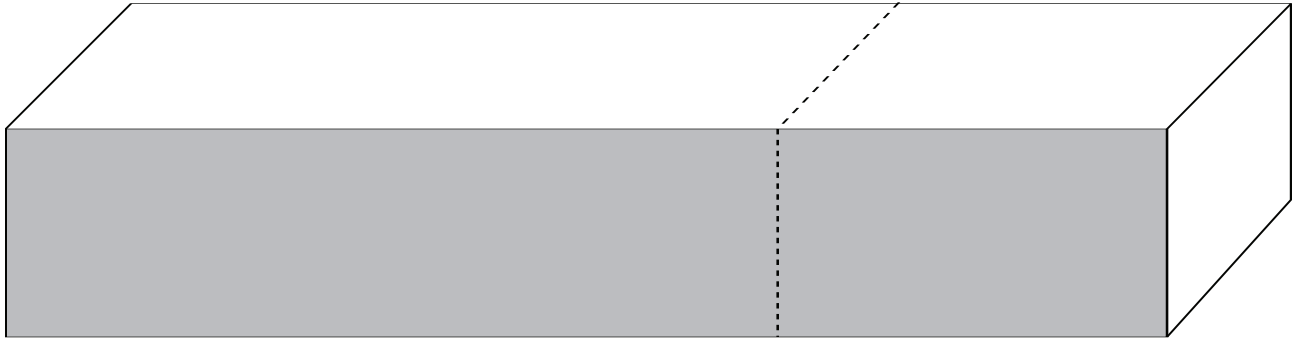

T-1 x 4SH 1 x 4
 T-1 x 6SH 1 x 6
FLATSTOCK

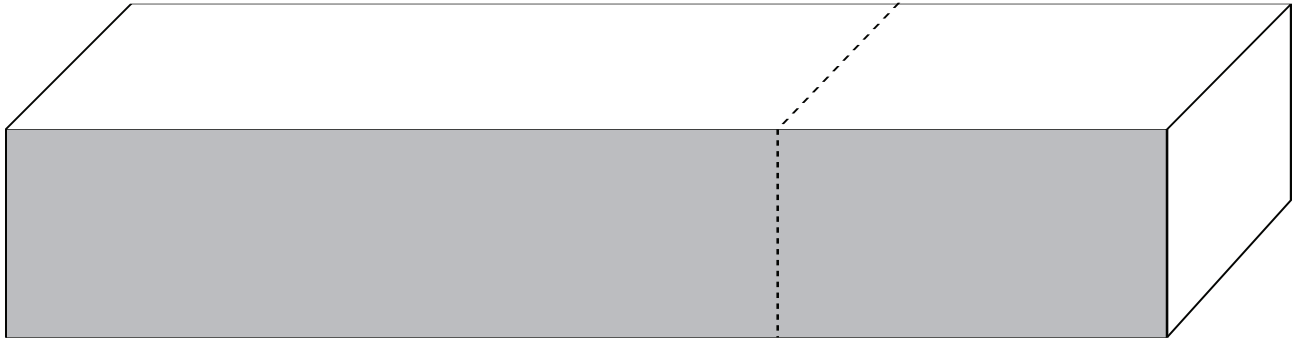

T-SL368 $\frac{3}{4} \times 4\frac{9}{16}$
 T-SL369 $\frac{3}{4} \times 4\frac{13}{16}$
JAMBSTOCK



MISCELLANEOUS

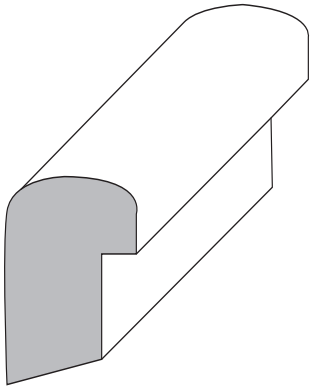

C-NJ612
 $\frac{11}{16} \times 1\frac{1}{8}$

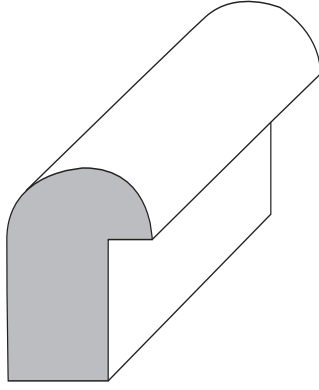

C-ST54B
 $\frac{11}{16} \times 1\frac{1}{16}$

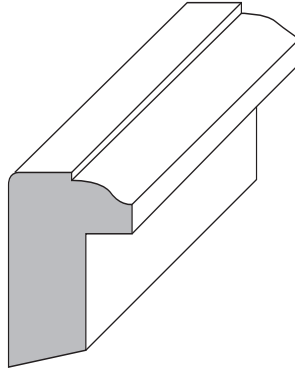

T-WM281
 $\frac{11}{16} \times 1$

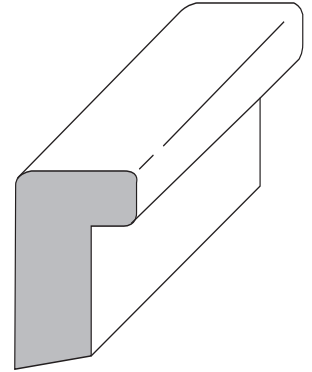

T-WM280
 $\frac{11}{16} \times 1$

BACK BAND

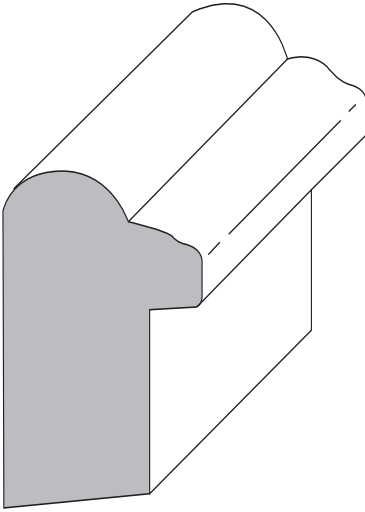

C-BB200
 $1 \times 1\frac{5}{8}$

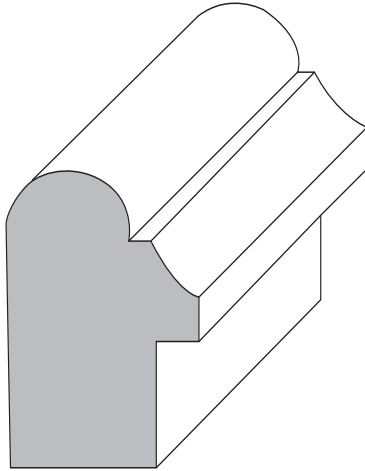

C-EC289
 $1 \times 1\frac{9}{16}$

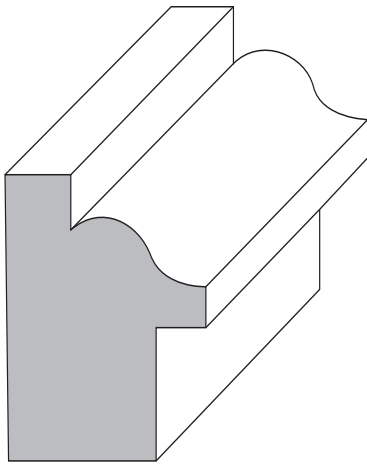

C-EC282
 $1 \times 1\frac{1}{2}$

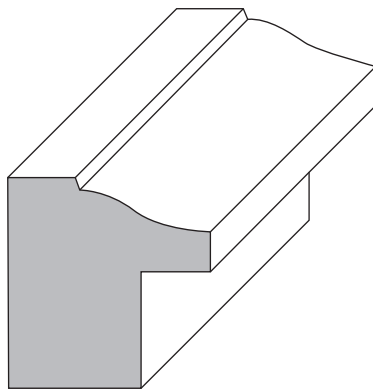

C-DC281
 $1 \times 1\frac{1}{8}$

DECORATIVE TRIM MOULDINGS

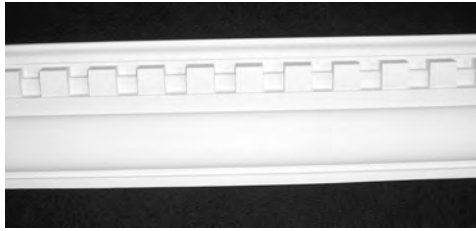

DE 100 $4\frac{3}{8} \times 3\frac{1}{2}$ pattern repeats $1\frac{3}{4}$



DE 112 $1\frac{7}{8} \times 2\frac{3}{8}$ pattern repeats $3\frac{3}{16}$



DE 106 $1\frac{5}{16} \times 1\frac{3}{8}$



DE 200 $1\frac{5}{8} \times \frac{3}{4}$



DE 107 $2\frac{5}{16} \times 1\frac{3}{16}$



DE 207 4 x 1



DE 108 4 x 4



DE 208 $2\frac{1}{2} \times \frac{3}{4}$ pattern repeats $1\frac{5}{16}$



DE 109 $2\frac{11}{16} \times 2\frac{1}{2}$



DE 209 $2\frac{1}{2} \times \frac{7}{8}$ pattern repeats $1\frac{5}{8}$



DE 110 $1\frac{7}{8} \times 2\frac{5}{16}$



DECORATIVE TRIM MOULDINGS



DE 210 $2\frac{3}{4} \times 3\frac{3}{4}$ pattern repeats $2\frac{5}{8}$



DE 211 $2\frac{1}{2} \times 1\frac{5}{8}$ pattern repeats $4\frac{1}{2}$



DE 213 $3\frac{1}{2} \times 1$ pattern repeats 2



DE 214 3×1

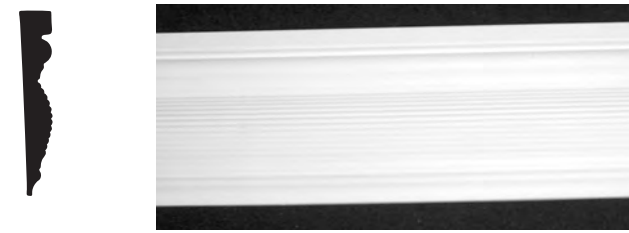

DE 215 $4\frac{1}{4} \times 3\frac{3}{4}$



DE 216 $7\frac{1}{2} \times 1\frac{1}{2}$ pattern repeats 1

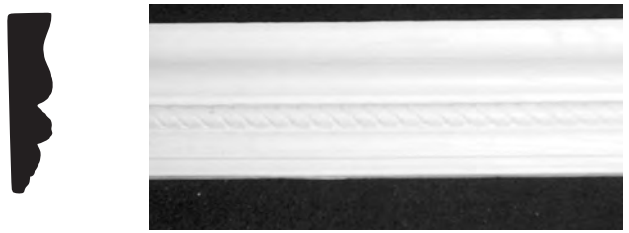

DE 218 $3 \times \frac{3}{4}$



DE 219 $4 \times \frac{3}{4}$



DE 220 $5\frac{1}{2} \times \frac{3}{4}$

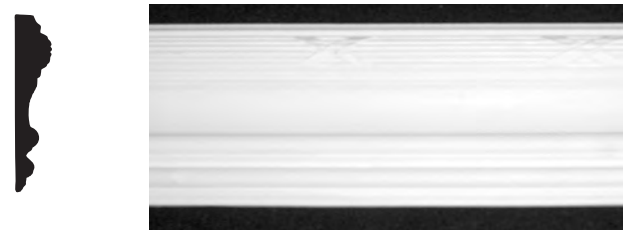

DE 221 $4 \times \frac{5}{16}$

DECORATIVE TRIM MOULDINGS



DE 222 $3\frac{7}{8} \times 1$



DE 223 $3\frac{1}{4} \times \frac{3}{4}$



DE 224 $3\frac{5}{8} \times \frac{5}{16}$



DE 225 $2\frac{7}{8} \times \frac{3}{4}$



DE 226 $3\frac{7}{16} \times \frac{3}{4}$ (DE 215 $4\frac{1}{4} \times \frac{3}{4}$)



DE 227 $4\frac{3}{4} \times 2$



DE 228 $7\frac{5}{16} \times \frac{1}{2}$ pattern repeats 1



DE 400 $2\frac{3}{8} \times 1\frac{1}{2}$



DE 403 $1\frac{1}{2} \times 1$



DE 404 $\frac{5}{16} \times \frac{1}{2}$



DE 406 $1\frac{7}{16} \times \frac{1}{2}$



DECORATIVE TRIM MOULDINGS

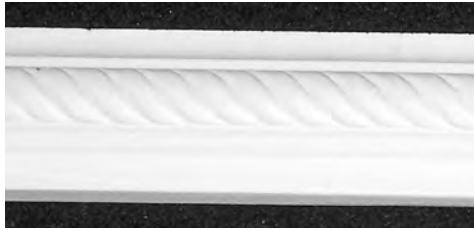

DE 407 $\frac{7}{8} \times \frac{3}{8}$



DE 415 $1\frac{1}{4} \times \frac{1}{2}$



DE 408 $3\frac{1}{4} \times \frac{5}{8}$



DE 416 $1 \times \frac{9}{16}$



DE 409 $1\frac{3}{4} \times \frac{5}{8}$



DE 900 $1\frac{3}{4} \times \frac{1}{2}$

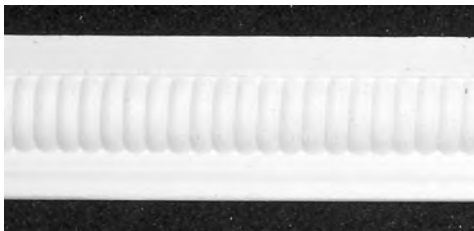

DE 411 $1\frac{3}{8} \times \frac{3}{4}$



DE 902 $1\frac{3}{16} \times \frac{7}{16}$



DE 412 $1\frac{1}{4} \times \frac{5}{8}$



DE 903 $1 \times \frac{3}{8}$



DE 414 $1\frac{1}{2} \times \frac{5}{8}$ pattern repeats $1\frac{1}{8}$

DECORATIVE TRIM MOULDINGS



DE 904 $\frac{5}{8} \times \frac{1}{4}$

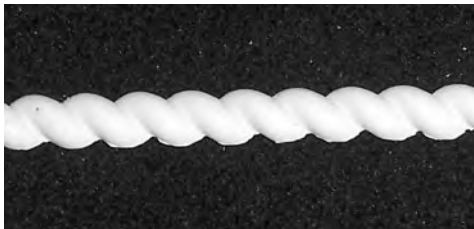

DE 905 $\frac{7}{16} \times \frac{1}{4}$



DE 911 $1 \times \frac{3}{8}$



DE 914 $\frac{1}{2} \times \frac{7}{16}$



DE 915 $1\frac{1}{4} \times 1\frac{1}{2}$

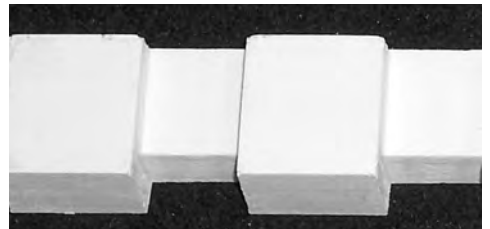

DE 916 $1\frac{1}{4} \times \frac{7}{8}$



DE 919 $\frac{15}{16} \times \frac{5}{8}$



DE 920 $2\frac{3}{8} \times 2\frac{1}{8}$

DURACRAFT COLUMNS

COLUMN CAPITALS



Corinthian - U-Cap 6" to 18"

	A	B	C
R-CAPIT-C-8"	6 1/2"	9 1/4"	11 1/2"
R-CAPIT-C-10"	8 1/8"	10 7/8"	14"
R-CAPIT-C-12"	10 1/4"	13 3/8"	19 1/4"



Greek Erectheum - U-Cap 6" to 12"

	A	B	C
R-CAPIT-G-8"	6 3/8"	3 1/2"	7 1/4" x 7 1/4"
R-CAPIT-G-10"	8 1/8"	4 7/8"	10 1/4" x 9 3/4"
R-CAPIT-G-12"	10 1/4"	5 1/2"	12 1/4" x 12 1/4"



Modern Composite - U-Cap 6" to 18"

	A	B	C
R-CAPIT-M-8"	6 1/2"	10 1/4"	14 1/2"
R-CAPIT-M-10"	8 1/4"	11 3/4"	14 3/8"
R-CAPIT-M-12"	10 1/4"	12 1/8"	17 1/8"



Roman Ionic - U-Cap 6" to 18"

	A	B	C
R-CAPIT-R-8"	6 1/8"	3"	7 3/4" x 7 1/2"
R-CAPIT-R-10"	8 1/8"	4 1/8"	9 3/4" x 10 1/4"
R-CAPIT-R-12"	10 1/8"	4 3/4"	12 3/8" x 13 1/4"



Temple of the Winds - U-Cap 6" to 18"

	A	B	C
R-CAPIT-T-8"	6 3/8"	7 1/4"	10 5/8"
R-CAPIT-T-10"	8 1/8"	9 3/4"	13 1/2"
R-CAPIT-T-12"	10 1/4"	11 3/8"	16 3/8"



Scamozzi - U-Cap 6" to 20"

	A	B	C
R-CAPIT-S-8"	6 1/4"	2 7/8"	9 1/2"
R-CAPIT-S-10"	8 1/4"	3 1/2"	13"
R-CAPIT-S-12"	10 1/8"	4 1/8"	16 1/2"

ResinArt East, Inc. Column Material has been tested for smoke development and flame spread under test standard: ASTM E84. Also, all ResinArt Columns have been tested for load bearing capability. Documentation available upon request.

WARRANTIES

ResinArt East, Inc. guarantees its DuraCraft Columns™ for the "lifetime" of ownership. Our warranty insures that DuraCraft Columns™ are not defective in material and/or workmanship. The "Lifetime Limited Warranty" is effective as long as the original purchaser owns the structure to which the column was originally and properly installed according to ResinArt's column installation instructions.

ResinArt East, Inc. will be solely responsible for determining whether to repair or replace its products that have not met performance standards due to material and/or workmanship deficiencies. ResinArt East, Inc. "Limited Lifetime Warranty" will cover up to the original cost of the product in question.

ResinArt East, Inc. "Limited Lifetime Warranty" does not cover damages resulting from the replacement of a substandard product. The "Limited Lifetime Warranty" will be in effect so long as the customer uses ResinArt East, Inc. products in a manner consistent with design capacities of the item.

How to Order ResinArt capitals:

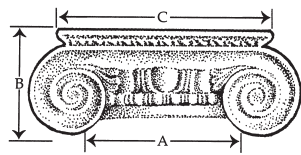

A=Base B=Height
C=Abacus

To assure a proper fit simply measure the top diameter of your column (see "A" in diagram) and match it to the bottom diameter of the capitals.

DURACRAFT COLUMNS

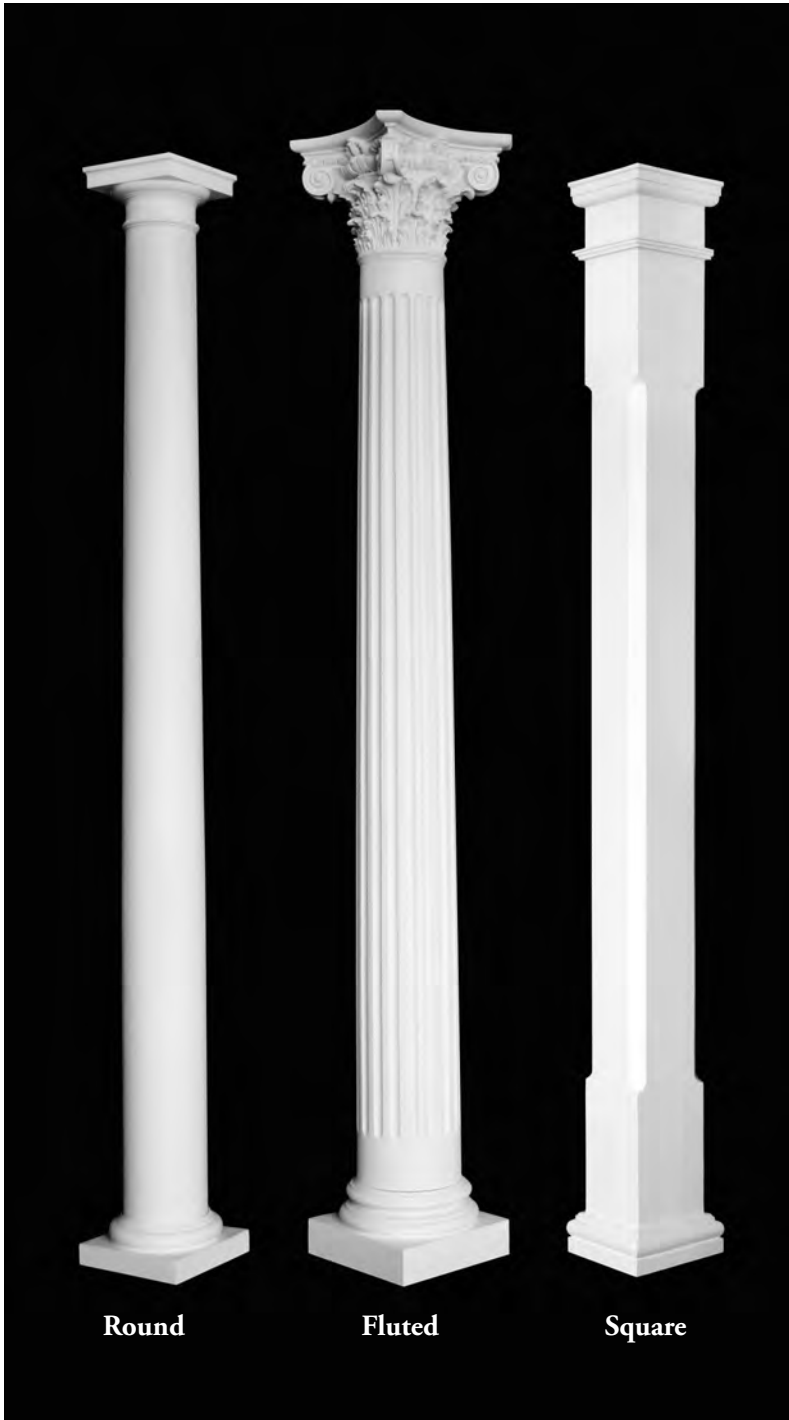

- Load Bearing
- Will not rot, bow, or crack, and are substantially more impact resistant than wood.
- No priming necessary for painting.
- Quick and easy to install.
- Maintenance free.
- Tapered in the Greek Tradition.

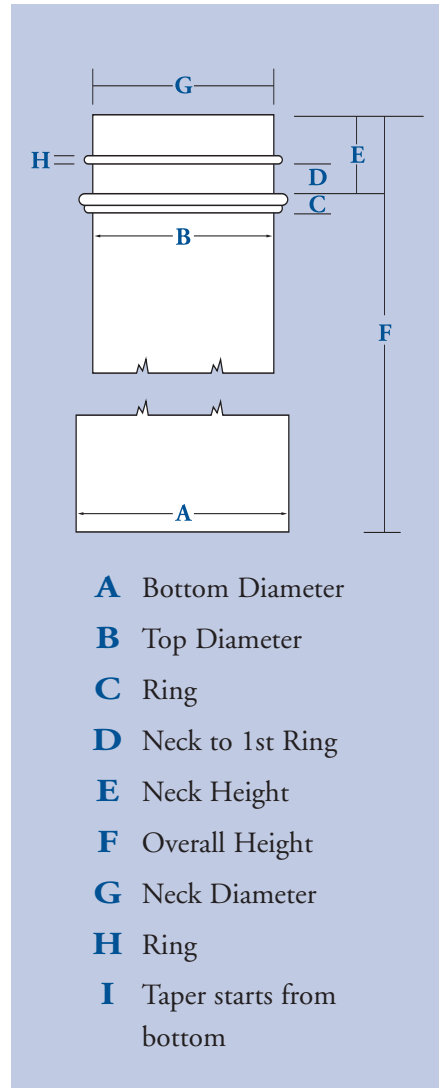

DURACRAFT	FITS COLUMN DIAMETER		
	8"	10"	12"
LOAD LIMIT	12,000 lbs. MAX	16,000 lbs. MAX	20,000 lbs. MAX



DURACRAFT COLUMNS

SQUARE COLUMNS

	COLUMN SIZE	ACTUAL WIDTH	CAP WIDTH	CAP HEIGHT	BASE WIDTH	BASE HEIGHT	TOTAL LENGTH	CHAMFER STARTS
R-SQCOL-S-8 x 8,10,12	8" sq.	7 ³ / ₄ "	10"	2 ¹ / ₄ ,2 ¹ / ₂ ,3"	10"	3 ¹ / ₂ ,4,4 ¹ / ₂ "	8,10,12'	16"
R-SQCOL-S-10 x 8,10,12	10" sq.	9 ³ / ₄ "	12"	2 ¹ / ₄ ,2 ¹ / ₂ ,3"	12"	3 ¹ / ₂ ,4,4 ¹ / ₂ "	8,10,12'	17"
R-SQCOL-S-12 x 8,10,12	12" sq.	11 ³ / ₄ "	14"	2 ¹ / ₄ ,2 ¹ / ₂ ,3"	14"	3 ¹ / ₂ ,4,4 ¹ / ₂ "	8,10,12'	18"

Square columns available with or without chamfer

ROUND COLUMNS/FLUTED

COLUMN SIZE	A	B	C	D	E	F	G	H	I	
R-COLUM-S-8 x 8	8" x 8'	7 ³ / ₄ "	6 ¹ / ₄ "	1"	1 ¹ / ₂ "	4 ⁷ / ₈ "	96"	6 ¹ / ₄ "	³ / ₈ "	33"
R-COLUM-S-8 x 9	8" x 9'	8 ³ / ₄ "	6 ¹ / ₄ "	1"	1 ¹ / ₂ "	4 ¹ / ₂ "	108"	6 ¹ / ₄ "	³ / ₈ "	30"
R-COLUM-S-8 x 10	8" x 10'	7 ³ / ₄ "	6 ¹ / ₄ "	1"	1 ¹ / ₂ "	4 ⁷ / ₈ "	120"	6 ¹ / ₄ "	³ / ₈ "	42"
R-COLUM-S-10 x 8	10" x 8'	9 ³ / ₄ "	8"	1"	1 ¹ / ₂ "	5 ¹ / ₂ "	96"	8"	³ / ₈ "	33"
R-COLUM-S-10 x 9	10" x 9'	8 ³ / ₄ "	8"	1"	1 ¹ / ₂ "	5 ¹ / ₂ "	108"	8"	³ / ₈ "	30"
R-COLUM-S-10 x 10	10" x 10'	9 ³ / ₄ "	8"	1"	1 ¹ / ₂ "	5 ¹ / ₂ "	120"	8"	³ / ₈ "	42"
R-COLUM-S-10 x 12	10" x 12'	9 ³ / ₄ "	8"	1"	1 ¹ / ₂ "	5 ¹ / ₂ "	144"	8"	³ / ₈ "	48"
R-COLUM-S-12 x 8	12" x 8'	11 ³ / ₄ "	10"	1"	1 ¹ / ₂ "	6"	96"	10"	³ / ₈ "	33"
R-COLUM-S-12 x 9	12" x 9'	8 ³ / ₄ "	10"	1"	1 ¹ / ₂ "	6"	108"	10"	³ / ₈ "	30"
R-COLUM-S-12 x 10	12" x 10'	11 ³ / ₄ "	10"	1"	1 ¹ / ₂ "	6"	120"	10"	³ / ₈ "	42"
R-COLUM-S-12 x 12	12" x 12'	11 ³ / ₄ "	10"	1"	1 ¹ / ₂ "	6"	144"	10"	³ / ₈ "	48"

For 8" Fluted Column: Flutes start 8" up from bottom and 2" down from C Ring

For 10" Fluted Column: Flutes start 10" up from bottom and 2" down from C Ring

For 12" Fluted Column: Flutes start 10" up from bottom and 2" down from C Ring

TUSCAN CAP & BASE



Tuscan - U-Cap 6" to 18"

	BASE	COL. DIA.	HT.
R-TUSCN-S-8CAP	9 ⁷ / ₈ "	8"	2 ¹ / ₄ "
R-TUSCN-S-10CAP	11 ¹ / ₄ "	10"	3 ¹ / ₂ "
R-TUSCN-S-12CAP	14 ¹ / ₄ "	12"	4"



	BASE	COL. DIA.	HT.
R-TUSCN-S-8BAS	10 ³ / ₄ "	8"	4 ¹ / ₂ "
R-TUSCN-S-10BAS	13 ¹ / ₄ "	10"	5 ¹ / ₄ "
R-TUSCN-S-12BAS	16 ¹ / ₂ "	12"	6"

ATTIC BASE

	BASE	COL. DIA.	HT.
R-MSAT-S-8"	10 ⁷ / ₈ "	8"	6"
R-MSAT-S-10"	12 ³ / ₄ "	10"	7"
R-MSAT-S-12"	15 ¹ / ₂ "	12"	8"

